



RichAuto--AutoNow A1X Motion Control System

MANUAL

For A11、A12、A15、A18
Download manual from
www.richnc.com.cn

Beijing RichAuto S&T Co., Ltd.

ADD: 5th floor No. 4 building No. 4 Yard Zhongguanyuan Road, Zhongguancun Life Science
Park,Beiqing St., Changping District, Beijing, China

P.C.: 102206

TEL: 010-53275118

FAX: 010-53275119

Thank you for choosing the products!

This manual helps you be familiar with the company's products, and get information about systems' components, configuration, etc.

This manual detailed knowledge of the system characteristics, operational processes, installation, commissioning, and safety precautions. Please read this manual carefully before using the system and machine, which will help you use it better.

Cautions:

1. Use of this product is strictly prohibited in the strong interference, strong magnetic field environment. Operating ambient temperature 0-70 °C, working environment humidity 0-90% (non-condensing).
2. Insert U disk in the correct direction. Do not pull out 50-pin cable when system run.
3. During processing U disk file process, do not pull out the U disk to prevent the interruption of data transmission.
4. Strictly prohibited metal, dust, and other conductive substances enter the controller.
5. The machine shell should connect the ground wire to ensure the safety of the work and to prevent interference.
6. Prohibited unauthorized disassembly, no user-repairable parts..
7. Unused for long periods of time, please pay attention to the power outage, and keep properly.
8. Pay attention to water, dust, fire when using it.
9. Do not use the corrosive chemical solvents to clean the equipment.
10. Spindle motor bearing life and its speed is inversely proportional.
11. Graver is very sharp. Do not touch when it is running in order to avoid injury; Do not use handkerchiefs, scarves to touch it to prevent embroiled damage.

Important Notice:

The Company shall not be responsible for any loss caused by improper using or breaking the correct operating procedures.

Beijing RichAuto S&T co.,Ltd owns this manual final interpretation, the company reserves the right to modify all information in this manual, including data, technical details, etc..

Contents

➤ Foreword	1
1. RichAuto system composition.....	3
1.1 System composition	3
1.2 Description of each component	4
1.2.1 Handle	4
1.2.2 Interface board.....	5
1.2.3 50-pin data transmission cable	5
1.2.4 USB communication cable	5
1.3 Interface board shell size	6
1.4 System start-up mode.....	6
2. Handle buttons introduction	6
2.1 Buttons introduction.....	6
2.2 Usage mode.....	7
2.3 Detail information for buttons function	8
3. Wiring Instructions	9
3.1 RichAuto interface board description	9
3.2 Interface board I / O description	10
3.3 Hardware wiring	12
3.4 Commissioning of the machine and control system	16
4. Menu Description	16
4.1 Menu category	16
4.2 Menu details.....	16
4.2.1 MACHINE SETUP	16
4.2.2 AUTO PRO SETUP	20
4.2.3 SYSTEM SETUP	23
4.2.4 OPERATE FILE	27
4.2.5 VERSION VIEW	28
5. Machine Operation	29

5.1	Return home.....	29
5.2	Import processing files.....	29
5.3	Manual operation	29
5.3.1	Manual speed switching and adjusting.....	33
5.3.2	Manual mode	34
5.3.3	Manual testing input and output.....	34
5.3.4	Manual switching coordinate system	33
5.4	Automatic processing operation	33
5.4.1	Set workpiece origin.....	33
5.4.2	Choose processing file.....	34
5.4.3	Set processing parameters	34
5.5	Operations during processing	35
5.6	Advanced Processing	38
5.6.1	Array work	33
5.6.2	Resume work.....	34
5.6.3	Tool changing	34
5.6.4	Part work	33
5.6.5	Calculate bound.....	33
5.6.6	Mill plane	34
5.6.7	Calculate work time.....	34
5.6.8	Find break no.....	33
5.6.9	Scale work	33
6.	A12 Plasma Cutting Motion Control System.....	44
6.1	Handle and buttons introduction.....	44
6.2	Output description.....	44
6.3	Arc setup&wiring.....	44
6.4	Parameters description	46
7.	A15--Multi-spindle Motion Control System.....	47
7.1	Handle and buttons introduction.....	47
7.2	Output description.....	47

7.3	Spindle wiring	48
7.4	Multi-spindle setup	49
7.5	G code example.....	51
8.	A18--Four-axis Linkage Motion Control System	52
8.1	Handle buttons introduction.....	52
8.2	Input description	52
8.3	Parameters description	53
8.4	G code example.....	53
9.	Appendix	54
9.1	System upgrade	55
9.2	U-disk Function	55
9.3	Servo driver parameters	56
9.3.1	YASKAWA Σ -7、 Σ -V	56
9.3.2	PANASONIC MINAS A5	58
9.3.3	DELTA ASDA-A2&B2	60
9.4	G code list	63
9.5	Tool setting(Tool measurement)	65
9.5.1	Fixed calibration.....	65
9.5.2	Mobile calibration	67
9.6	Calculate pulse equivalent	70
9.6.1	Stepper driver	70
9.6.2	Servo driver	72
9.6.3	Proportion calculation method	75
9.7	Common problems and troubleshooting.....	70
9.7.1	Solutions of the faults display on the screen	76
9.7.2	Faults in practical operation	77
9.7.3	Electrical components and wiring problem	80

➤ Foreword

1) System Introduction

RichAuto A1X motion control system independently developed by Beijing RichAuto S&T Co., Ltd and it can be widely applied to machinery, advertisement, woodworking, mold engraving machines, laser, flame, plasma cutting machines, and others in the machine control field.

RichAuto A1X make DSP as the core of the system, High-speed processing; Use embedded structure, high degree of integration and strong stability make installation and operation easy; Support U disk, removable storage card reader; High speed transfer, no longer dependent on the computer to realize off-line operation.

2) Characteristics

1. Adopting position control mode, support 3-axis and 4-axis linkage motion control, double Y drive.
2. Standard with 8 Input/Output interface board.
3. Support various processing format, such as G code, PLT, bitmap and DXF etc.
4. Intelligent memory function, support power failure protection and breakpoint processing function.
5. Support portable storage mode function.
6. Multi-coordinate memory function. Provide 9 work coordinates system, the user can switch among the 9 coordinates, each coordinate system can save a process origin information.
7. Support adjusting spindle frequency during processing. The spindle frequency from 0 to maximum frequency is divided into 8 gears, 1 - 8 gear can be processed directly adjust up and down without suspend processing.
8. Support adjusting speed ratio during processing. Users can adjust the speed ratio from 0.1-1, ascending or descending per 0.1 numerical.
9. Simple manual operation mode. Including “Continue, Step, Dist”, manual operation becomes more simple and convenient.

10. Support M,F code and other expanded codes,special code can be customized according to actual request.
11. Built-in 512 Mb memory.Communication by USB interface.
12. Unique handheld form to realize holding by one hand. Liquid crystal display and 16 buttons make operating intuitive and flexible.No longer dependent on the computer to realize off-line operation.
13. Self-test function,system supports I/O signal detection capabilities to make remote maintenance easy.
14. Support multiple languages, such as Spanish, French, Arabic, etc.
15. System supports automatically dynamic upgrading that make remote operation and remote maintenance convenient.

3) Product Parameters

Product Model	RichAuto-A1X		
CPU	DSP	Power Failure Protection	Support
Built-in Memory	512Mb	Breakpoint Processing Function	Support
Screen	128*64 Monochrome Screen	Power Supply	DC 24V
Communication Port	U Disk	Manual Mode	Continue、 Step、 Distance
Number of Linkage Axes	3-4 axes	Interpolation Method	Line、 Arc、 Spline
Control Signal	Common Anode	Soft/Hard Limit	Support
Drive System	Stepping/Servo Motor	Maximum Pulse Frequency	1MHz
Minimum Input Unit	0.001mm	Password Protection	Support
Language	Simplified/Traditional Chinese,English,Other languages can be customized		
Standard Configuration	DSP Handle; 50-pin Cable、 8 I/O Interface Board,USB Cable		

4) Product Model

	Model	Name
AutoNow A1X Motion Control System	A11	Three-axis Linkage Motion Control System
	A12	Plasma Cutting Motion Control System
	A14	Dispensor Motion Control System
	A15	Multi-spindle Motion Control System
	A115	Double Z Motion Control System
	A16	Side-spindle Motion Control System
	A18	Four-axis Linkage Motion Control System
	A123	Four-axis Linkage + Multi-spindle Motion Control System
	A132	Lathe Motion Control System

1. RichAuto System Composition

1.1 System composition

RichAuto control system contains the following parts: handle , interface board, a 50-pin data transmission cable, an USB communication cable.



Handle

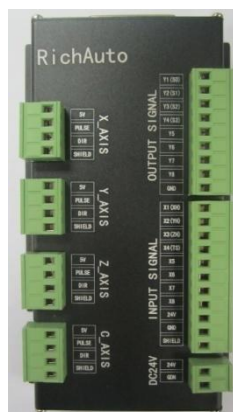

Interface board



50-pin data transmission cable



USB communication cable

1.2 Description of each component

1.2.1 Handle

As shown below, including 6 parts:



- 1) Screen: 128 * 64 resolution LCD to display the machine motion, system settings and other information.
- 2) Button board: Contains 16 buttons to input system parameter information and operate the machine.
- 3) U-disk interface: Interface of U-disk (FAT16/32) and the memory card.
- 4) Company LOGO: **RichAuto**.
- 5) 50-pin data cable interface: Connect the handle with the interface board to realize controlling the machine. Including 2.5m, 4m, and 6m.
- 6) USB cable interface: It is used to connect the handle with your computer.

1.2.2 Interface board

As shown below, including 5 parts:

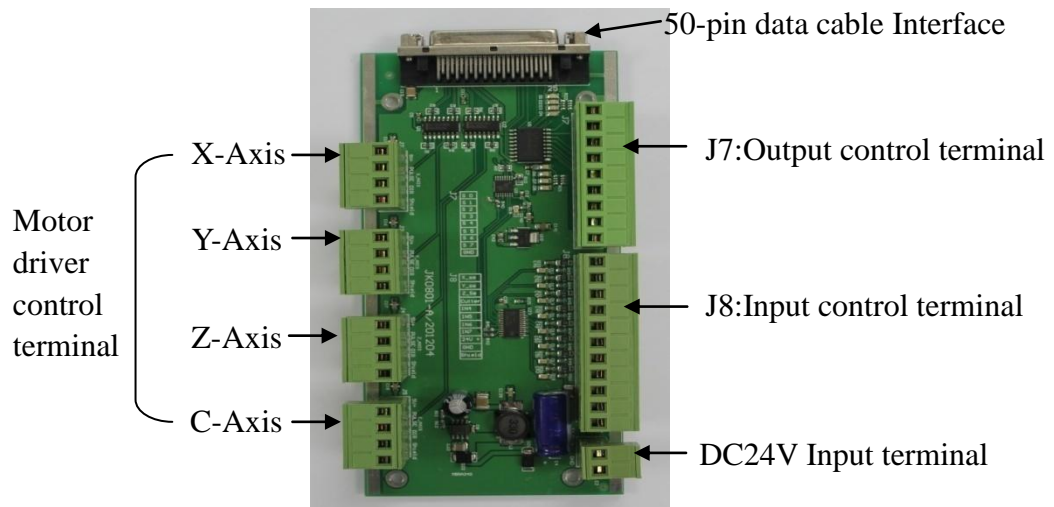

- 1) 50-pin data cable port: connect handle with interface board.
- 2) Output control terminal: including spindle On/Off signal,work&alarm led siganl etc..
- 3) Input control terminal: including machine origin detection switch, toolsetting, driver alarm, hard limit switch, and E-stop signal, pedal switch.
- 4) Power supply terminal: DC24V,3A
- 5) Motor driver control terminal.

1.2.3 50-pin data transmission cable



1.2.4 USB communication cable



1.3 Interface board shell size

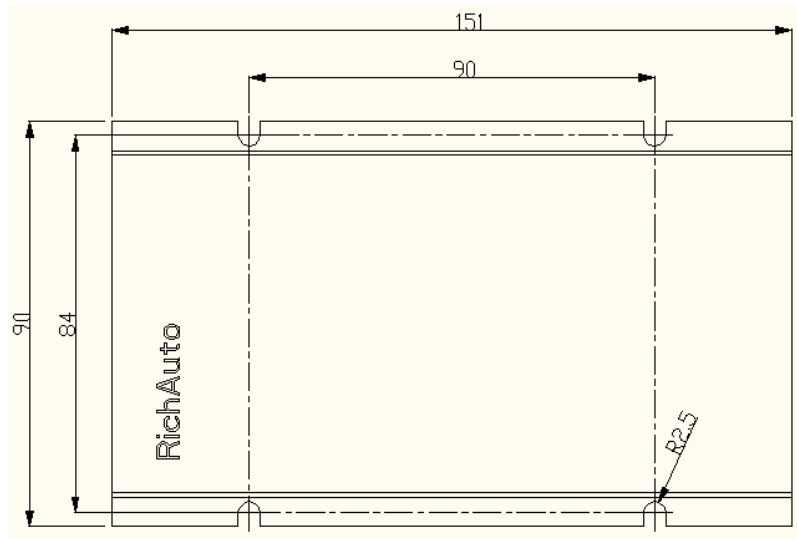



Ratio:1: 1 , Unit: mm

1.4 System start-up mode

Normal start: After power up, the system enters the homing type interface and manual control interface.

Emergency start: After power up, if the system can not enter the homing type interface and manual control interface, users need to make an emergency start operation.

Firstly, cut off the power supply, and then press and hold button “”, power up again,

after 3-4 seconds, release button “”, if system enters the Emergency state, you can choose to “Update System”, “Format System”, and then restart the system.

2. Handle Buttons Introduction

2.1 Buttons introduction

RichAuto motion control system defines 16 buttons according to functional requirements.

Each button has one or more functions under different work status.

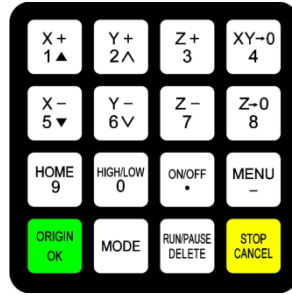
Buttons picture











2.2 Usage mode





RichAuto control system provide two modes of buttons' operation, including one-touch button & Combination button.

One-touch button: Press one button on handle.



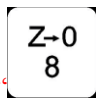

Combination button: Press two buttons at the same time to achieve the operation; the operation step: press one main function button and meanwhile press a second accessibility button, and then release the two buttons at the same time to realize the combination button operation.





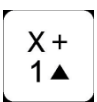

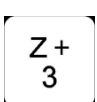
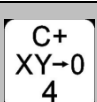
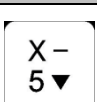
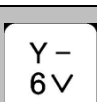
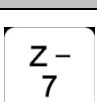
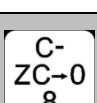
List of Combination buttons:

	Combination button	Function
1	 + "0-9" Number Buttons "MENU" + "0-9"	Switch the coordinate system (0 for the mechanical coordinate system, 1 - 9 for the work coordinate system)
2	 + 	Start Z-axis automatic tool setting
3	 + "1-8" Number Buttons "RUN/PAUSE DELETE" + "1-8"	Start the breakpoints processing (support number 1 - 8)
4	 + 	Start advanced processing
5	 +  + 	To switch gear shaft under manual mode
6	 + 	Repeat last time processing

7	 + 	Set stop position
8	 + 	System upgrade
9	 + 	Quit buttons check

2.3 Detail information for buttons function

Name	Function
	Positive movement of X axis, menu upward , figure 1 inputting
	Positive movement of Y axis, speed-up processing speed, figure 2 inputting
	Positive movement of Z axis, figure 3 inputting, increase spindle speed during processing
	Set X axis and Y axis work origin, figure 4 inputting
	Negative movement of X axis, menu downward, figure 5 inputting
	Negative movement of Y axis, solw down processing speed, figure 6 inputting different property selecting in Menu
	Negative movement of Z axis, figure 7 inputting, reduce spindle speed during processing
	Set Z axis work origin, figure 8 inputting
	Machine back home, figure 9 inputting,check information during processing
	High or low speed selection under manual mode, figure 0 inputting,change work coordinate & mechanical coordinate during processing

	Spindle start/stop, decimal point inputting
	Enter menu setting, negative sign inputting ,check information during processing
	Back to work origin,confirm motions /inputting/operating
	Manual mode, continue/step/distance to select
	Run or pause processing,delete inputting data, different property selecting in menu
	High/low speed parameter adjust under manual mode, quit process stop/selections, inputting and operating cancel

3. Wiring Instructions

3.1 RichAuto interface board description

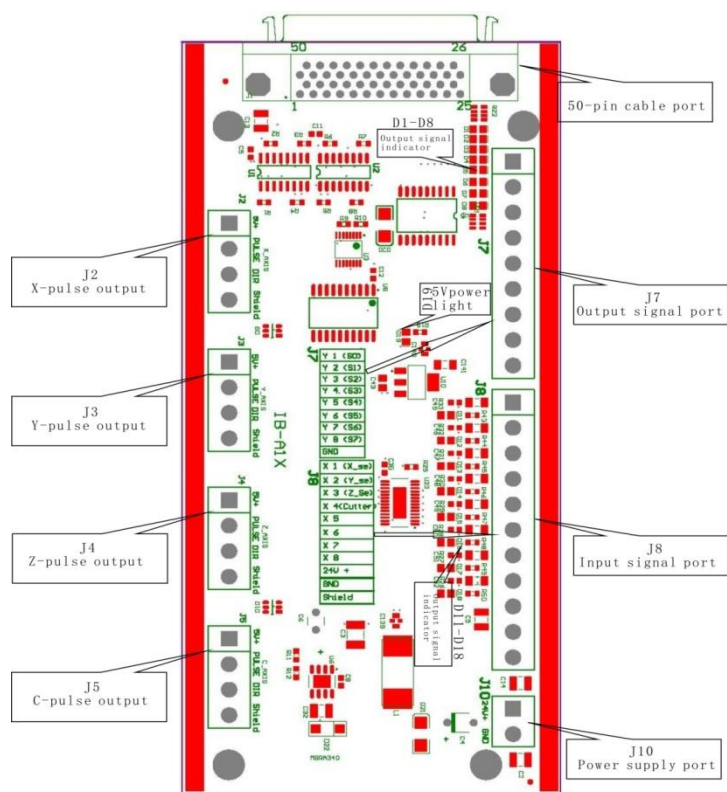

3.2 Interface board I / O description

Port label	Port definition	Signal description	Pin functions and parameters	Notes
DC24V	24V+	+24V DC power input	Supply DC24V for interface board	24V ($\cong 3A$)
	24V-	Power GND		
X_AXIS	5V	Common anode	Output 5V	Do not impose voltage on this pin
	PULSE	X axis pulse signal	Output voltage $\cong 3V$; Drive current $\cong 8mA$	
	DIR	X axis direction signal	Output voltage $\cong 3V$; Drive current $\cong 8mA$	
	SHIELD	Shielded signal		Do not impose voltage
Y_AXIS	5V	Common anode	Output 5V	Do not impose voltage on this pin
	PULSE	Y axis pulse signal	Output voltage $\cong 3V$; Drive current $\cong 8mA$	
	DIR	Y axis direction signal	Output voltage $\cong 3V$; Drive current $\cong 8mA$	
	SHIELD	Shielded signal		Not GND
Z_AXIS	5V	Common anode	Output 5V	Do not impose voltage
	PULSE	Z axis pulse signal	Output voltage $\cong 3V$; Drive current $\cong 8mA$	
	DIR	Z axis direction signal	Output voltage $\cong 3V$; Drive current $\cong 8mA$	
	SHIELD	Shielded signal		Not GND
C_AXIS	5V	Common anode	Output 5V	Do not impose voltage on this pin
	PULSE	C axis pulse signal	Output voltage $\cong 3V$; Drive current $\cong 8mA$	
	DIR	C axis direction signal	Output voltage $\cong 3V$; Drive current $\cong 8mA$	
	SHIELD	Shielded signal		Not GND

Port label	Port definition	Signal description	Pin functions and parameters	Notes
OUTPUT SIGNAL	Y01	FWD/REV	Logic low	Connect FWD&DCM, do not connect Y01
	Y02	Multi-Speed 1	Logic low	
	Y03	Multi-Speed 2	Logic low	
	Y04	Multi-Speed 3	Logic low	
	Y05	Alarm indicator	Logic low	
	Y06	Run indicator	Logic low	
	Y07	deifnable	Logic low	
	Y08	deifnable	Logic low	
	24V	Output DC 24V	Output 24V	Supply DC24V for indicators
	GND	GND		
	SHIELD	Shielded signal		
	INPUT SIGNAL	X01	X Machine zero	Logic low
X02		Y Machine zero	Logic low	For external connection with mechanical,photoelectrical or proximity switch
X03		Z Machine zero	Logic low	For external connection with mechanical,photoelectrical or proximity switch
X04		Tool setting	Logic low	
X05		Driver alarm	Logic low	
X06		Hard limit	Logic low	
X07		E-stop	Logic low	
X08		Pedal switch	Logic low	Pause during processing&repeat after processing
24V		Output DC 24V		For active sensors
GND		GND		For active sensors
SHIELD		Shielded signal		

3.3 Hardware wiring

Installation Requirements: Power (24V, 3A), it is better to add a filter to prevent the electric field interference. If choosing origin detecting switches of different power supply type, the special testing switching power is needed. (24V origin detecting switch is the best choice)

RichAuto control system realizes its control through the connection between the interface board and CNC machine. Interface board terminal can be divided into input terminal and output terminal

Input terminal: INPUT SIGNAL DC24V(Power Supply)

Output terminal: X,Y,Z,C axis pulse signal output terminal,OUTPUT SIGNAL

Input terminal

Power Supply

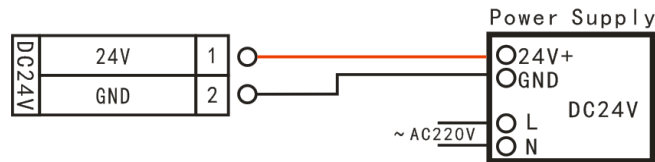

INPUT SIGNAL

1. Machine Origin Y and Z are the same as X

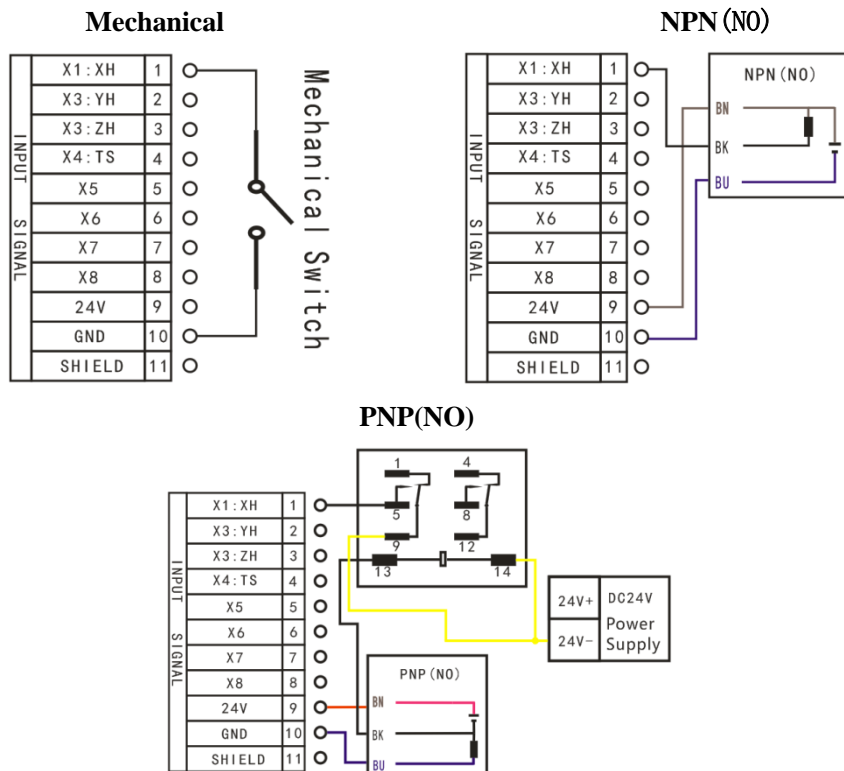

2. Tool-setting input

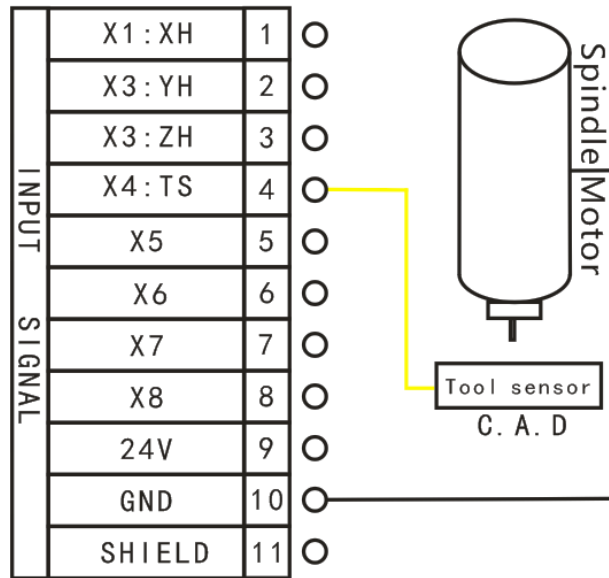

3. X5-X8 e.g.-Servo alarm

Alarm signal normal open, wiring in series(modify the definition of X5 level).

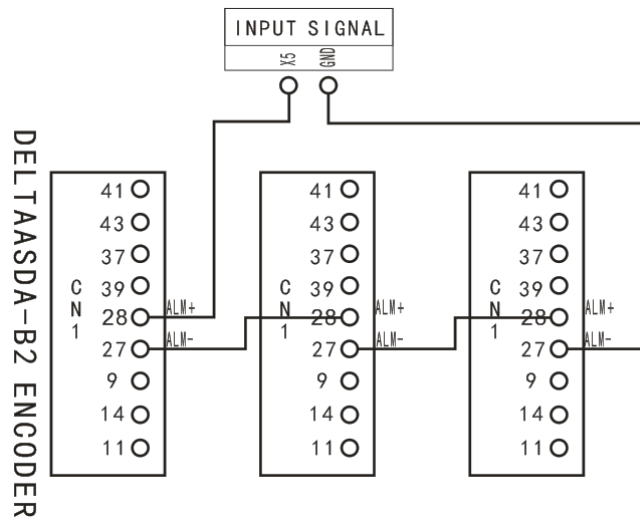

Alarm signal normal open, wiring in parallel

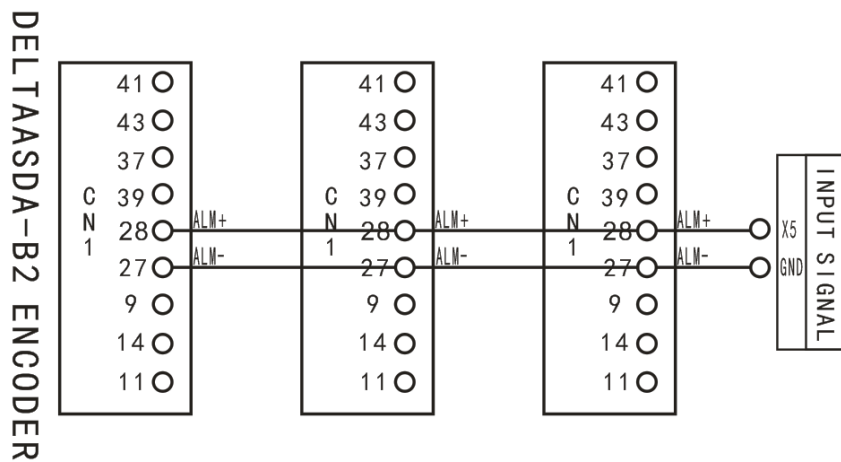

Output terminal

X pulse signal wiring Y and Z are the same as X

Stepper driver:

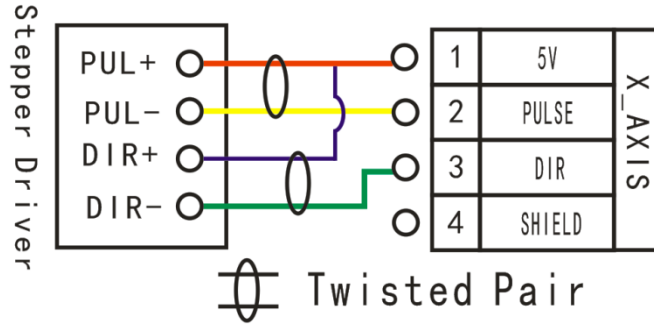

Servo driver: Σ -7 same as Σ -V

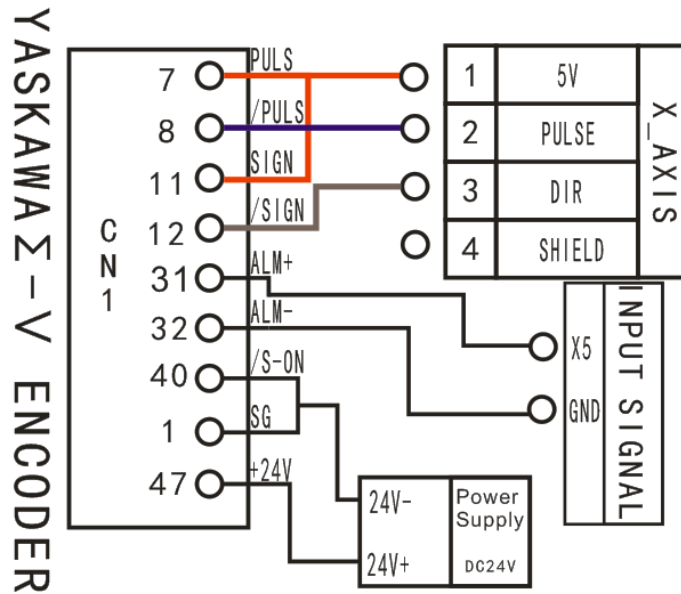

Motor Brake: YASKAWA Σ -V (Σ -7 same as Σ -V), Set Pn50F=0300

Wired as follows:

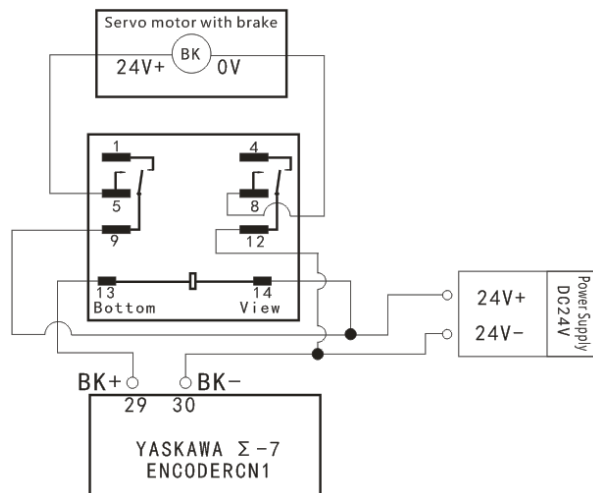

OUTPUT SIGNAL Y1-Y4

Count 3-1

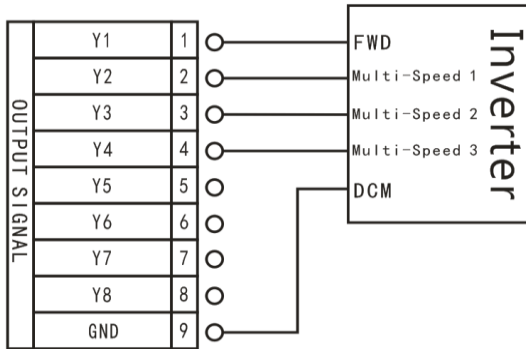

Count 3-2

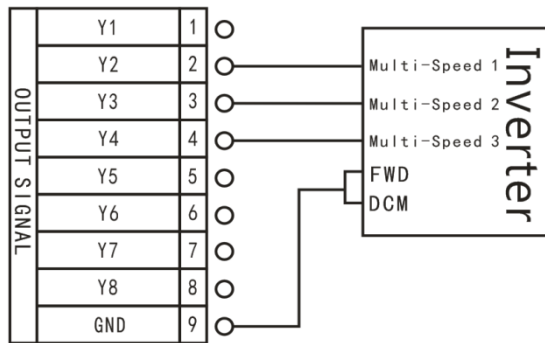

Count 1(ON/OFF)

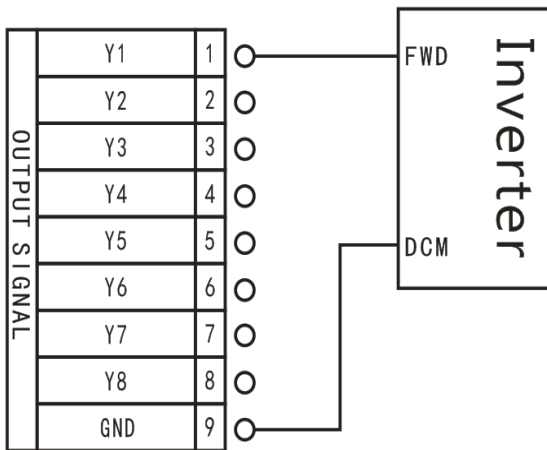

Spindle State

		Spindle ON/OFF		
		1Shift	↓	↑
Spindle Count 3	1Shift	↓	↓	↓
	2Shift	↑	↓	↓
	3Shift	↓	↑	↓
	4Shift	↑	↑	↓
	5Shift	↓	↓	↑
	6Shift	↑	↓	↑
	7Shift	↓	↑	↑
	8Shift	↑	↑	↑

CAUTION: FWD and DCM has Connected in Parallel in some inverters, please do not need to connect Y1 in such situations, you only need to connect DCM with GND of interface board, without having to reset the spindle gear.

OUTPUT SIGNAL Y5-Y8

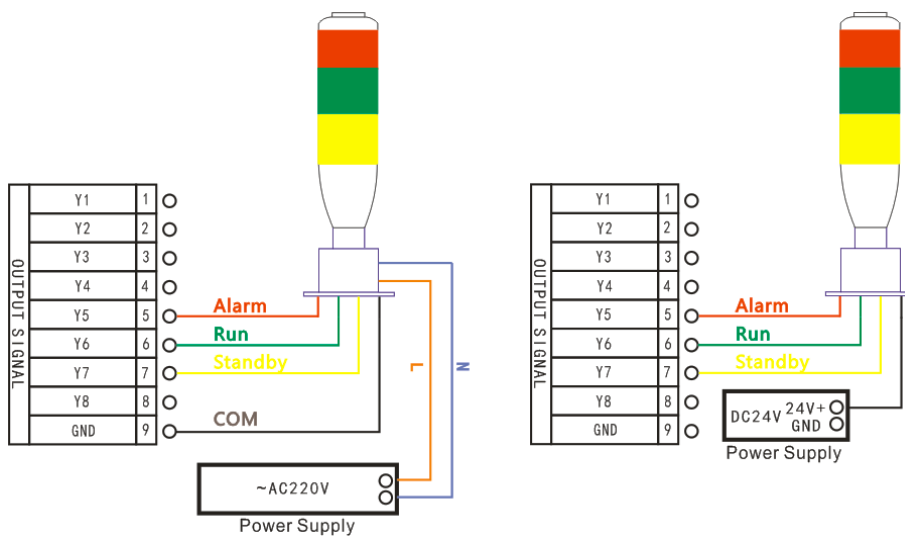

You can connect the machine with the control system when the above setting is over.

3.4 Commissioning of the machine and control system

1. After turn on the power, users can manually move each axis and confirm the direction. If the movement direction and definition direction are opposite, users can change the motor phase sequence (A+, A-/B+, B-) or modify servo parameters.
2. According to the original location of the machine coordinates, users can enter into menu-machine setup-home setup- home direction to reset it.



3. Double-press “”-manual voltage setup (the upper arrows stand for input voltage) to check whether the home switch is working.

The machine is in good connection if all the above setting is ok.

4. Menu Description

4.1 Menu category

According to menu function, RichAuto sytem menu divided into:

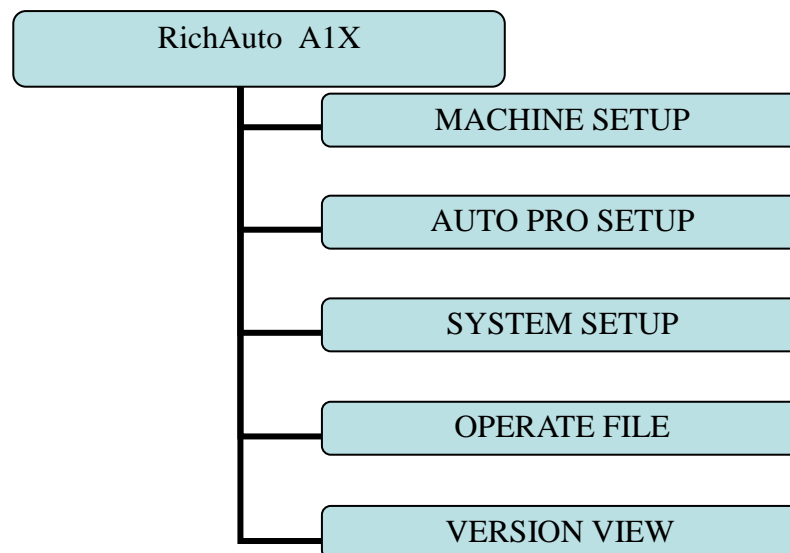

4.2 Menu details

4.2.1 MACHINE SETUP

Users can set the parameters about machine hardware under”Machine Setup”. It is set by

machine producer according to device type. If machine hardware parameter is not changed, this parameter should also not change. If machine users need to change, please consult machine producer.

Machine setup chart

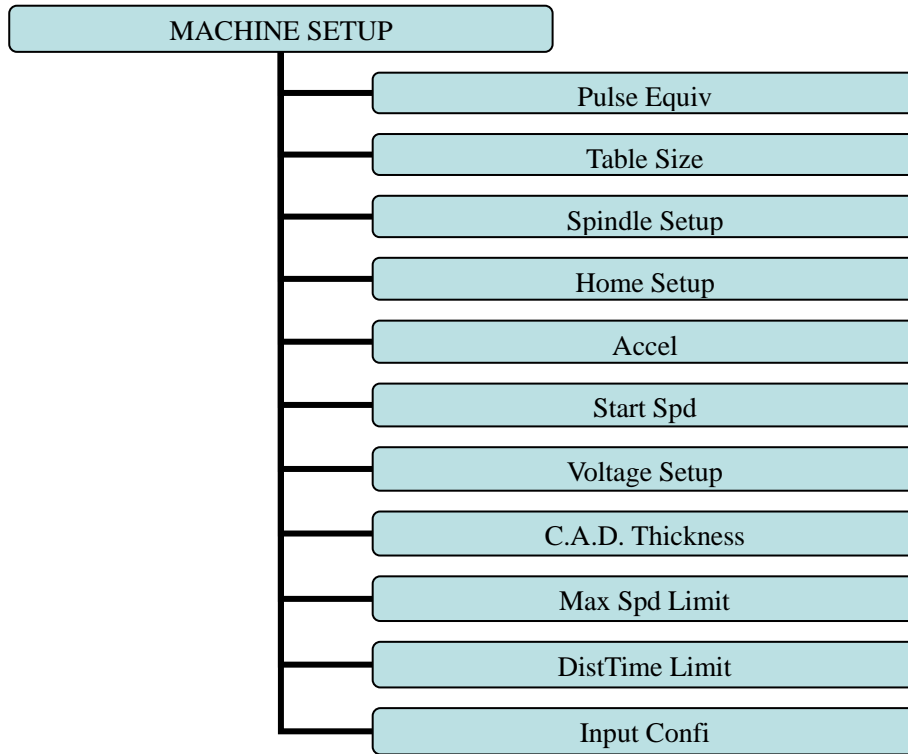



1. Pulse Equiv

Linear axis: The number of pulses of the system needs to send when machine moves every 1mm. Unit: pulse/mm.

Rotary axis: The number of pulses of the system needs to send when machine turns every 1 angle. Unit: pulse/angle.

Calculation methods are detailed in Appendix 7

Setting: Enter “pulse equiv”, cursor is in the X-axis pulse equivalent position, press



“”/“” to move cursor to where users want to modify. Press “”, input the



new number, and press “” to save.

2. Table Size

RichAuto system make the table size as the soft limit values, in order to prevent machine

move over travel, machine size must be less than or equal to the value of the actual motion displacement machine.

Setting: Enter “Table Size”, press “”/“” to move cursor to where users want

to modify. Press “”, input the new number, press “” to save.

3. Spindle Setup

Spindle delay: Unit: ms; including start delay and stop delay.

Spindle state: Used to set Spindle states ---multi-speed or only on/off status. See detailed settings at **OUTPUT SIGNAL**-spindle output wiring.

4. Home Setup



Home speed: Every axis movement speed when back home, system default speed X.Y: 3000 mm/minute, Z: 1800 mm/minute.



Home order: Every axis movement order when back home

Including:

- ◇ Z,X and Y Z,X,Y Z,Y,X
- ◇ Z only X and Y,Z X,Y,Z
- ◇ Y,X,Z XY home X,Y home
- ◇ Y,X home None home X home only XZ and Y

Home direction: Every axis movement direction when back home, this direction depends on the position where home switch is on the machine. If home switch installed in the positive direction, so home direction should be “positive”, and vice versa.

Setting: Enter “home dir”, press “”/“” to move cursor to where users want to

modify. Press “” to change home direction, press “” to save the change.

5. Accel (Acceleration) Unit: mm/s²

The maximum acceleration value during acceleration and deceleration movement, improve (including straight and curved motion) processing capabilities. If acceleration is too large, it may cause the motor losing steps, jitter and even whistle, if too small, it will lead to accelerated slowly

and reduce the operating speed of the entire graph. System default: linear acceleration is 800 mm/s^2 , curve acceleration is 1000 mm/s^2 , the proposed curve acceleration is 1-1.5 times the linear acceleration value.

6. Start Speed Unit: mm/minute

The speed of axis started directly from standstill. Not starting from zero speed, but starting directly from a certain speed, so it can shorten the overall processing time, but do not set this speed too high. Set too high, it will cause the motor losing steps, jitter and even whistle; Set too small, it will reduce the operating speed of the entire graph. If the inertia of motion axes (axis heavier), users can set a smaller start speed, if the inertia of motion axes smaller (lighter shaft), users can set it bigger.





7. Voltage Setup

Set input and output signal terminal status, “↓” means normal open, “↑” means normal closed. Including two rows of arrow:

The upper arrow indicates the input level: Set input signal level. The top four: 0, 1, 2, 3 positions correspond X, Y, Z axis back home, tool setting signal; 4-7: driver alarm, hard limit, E-stop signal, pedal switch.

The under arrow indicates the output level: Set output signal level. The top four: 0, 1, 2, 3 positions correspond spindle On/Off, multi-speed 1, multi-speed 2, multi-speed 3 signal, 5, 6, 4, 5 positions correspond alarm indicator, work indicator signal.

	X1	X2	X3	X4	X5	X6	X7	X8
Input level	0	1	2	3	4	5	6	7
	↓	↓	↓	↓	↓	↓	↓	↓
Output level	0	1	2	3	4	5	6	7
	↓	↓	↓	↓	↓	↓	↓	↓
	Y1	Y2	Y3	Y4	Y5	Y6	Y7	Y8

Setting: Press “” / “” to move around, Press “”, “” to

move up and down, press “” to change the direction of the arrow.

8. C.A.D.(Tool sensor) Thickness Unit: mm

This thickness should input by actual, if it is bigger than the actual thickness, Z axis may cut

too much; if smaller, Z axis can't touch workpiece. This parameter can only take effect when user use auto toolsetting function.

9. Max Spd Limit (Max Speed Limit) Unit: mm/minute

Set machine top speed, it only takes effect during processing, system default max speed X,Y is "60000000 mm/minute", "Z+" is "1800 mm/minute", "Z-" is "3000 mm/minute".

10. DistTime Limit Unit: second

Users select diatance mode, and if the machine does not move in a certain period of time (system default is 30 seconds), the system will go back to continuous mode to prevent Z-axis collision risk because of the customer forgot to switch back to continuous mode and set a large distance value.

11. InputConfi (Input Port Configuration)

To open or prohibit input signal, if the interface board does not connect X5-X8 signals, users can prohibit X5-X8 signals.

Setting: Press "Y+ 2^" and "Y- 6 v" to move up and down, press "RUN/PAUSE DELETE" to change

enable or disable, and then press "ORIGIN OK" to confirm.

4.2.2 AUTO PRO SETUP

Users can set the parameters about processing under "AUTO PRO SETUP".

Auto Pro Setup chart

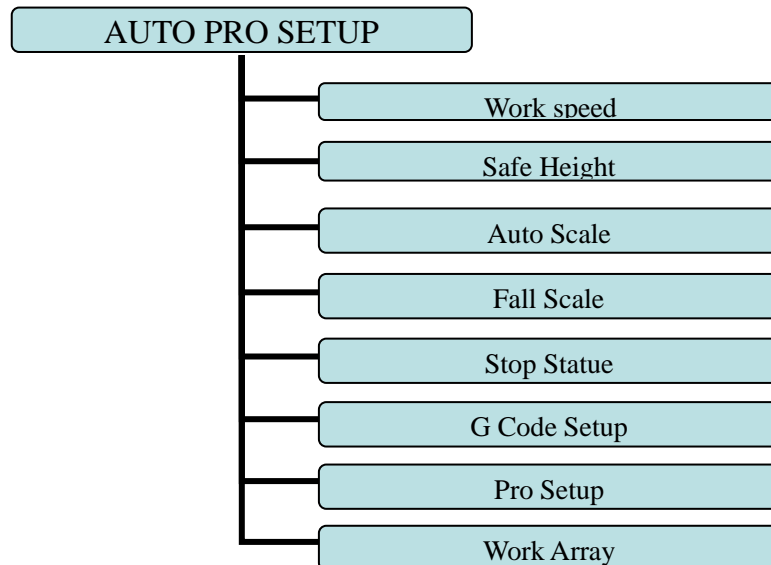

1. Work Speed Unit: mm/minute

Including work speed and fast speed, system default is 3000 mm/minute.

2. Safe Height Unit: mm

The height of Z axis rise during processing. System default is 40.000 mm.

3. Auto Scale

Actual processing speed=work speed*auto scale, system default auto scale does not affect the fast speed.

4. Fall Scale

Fall scale, system default is 0.200. fall speed=fast speed*fall scale, the maximum fall speed is Z axis negative limit speed*fall scale.

Fall height, system default is 5.000mm, fall down scale takes effect when the spindle falls to the fall height.



5. Stop Statue

Setup stop position after auto processing.

Work stop state	
FinAct	Pickup
XCoordnt	0.000
YCoordnt	0.000
ZCoordnt	0.000

(Coordnt=coordinate)



Set stop position: Press “” / “” to move cursor to where users want to

modify. Press “”, input the new number, press “” to save.

Press “” to enter finish action list:

FinAct
Pickup Z
Back To Work Org
Back Home
Back Position
None move

(FinAct=Finish Action, Org=Origin)

Press “” / “” move cursor to where users want to modify, press “”

to save.





6. G Code Setup

Set special G code attribute, according to the actual need to make changes.

Attribute Of G Code	
F Read	Ign F/Read F
AbsCntr	Off/On
T Read	Ign T/ Read T
Spindle	NTLLG/FORCE/INSTR
FilterJD	None/ Adj Z Filter
S Read	Ign S/ Read S
Read G54	Ign G54/ Read G54
Read G49	Ign G49/ Read G49
Read G40	Ign G40/ Read G40
CodeHead	Skip/NoSkip
Input TO	-1

(Ign=Ignore, Adj=Adjt=Adjust, AbsCntr= Absolute center)





CAUTION: Blue parts indicate system default attributes.

Setting: Press “” / “” move cursor to where users want to modify, press “” to select the attribute users want, press “” to save.

7. Pro Attribute

Set some special settings about processing according to the actual need.

Work attribute	
Adj Z	Adj Z/Rev Z
Adjust WP	None/Adjt
Ignore Z	Read Z/ Ign Z
CirLmt	55.556
StepWork	Contns/Single
ATC Spld	Auto/None

Setting: Press “” / “” move cursor to where users want to modify, press “” to select the attribute users want, press “” to save.

8. Work Array

Set array parameter, including columncount, Rowcount, Columnspace, Rowspace, Interval (unit: ms)

Columnspace: File spacing of X direction

Rowspace: File spacing of Y direction

Total Processing times= columncount* Rowcount

Interval: System default 0, it means no wait.

During processing, if users need to change processing materials after completion of each processing, you need set time interval a negative number. When the first time processing is completed, the screen prompt: waiting for the next array processing, press any key to start the next array processing at this time, if not press, system keep waiting.

4.2.3 SYSTEM SETUP

System Setup Chart

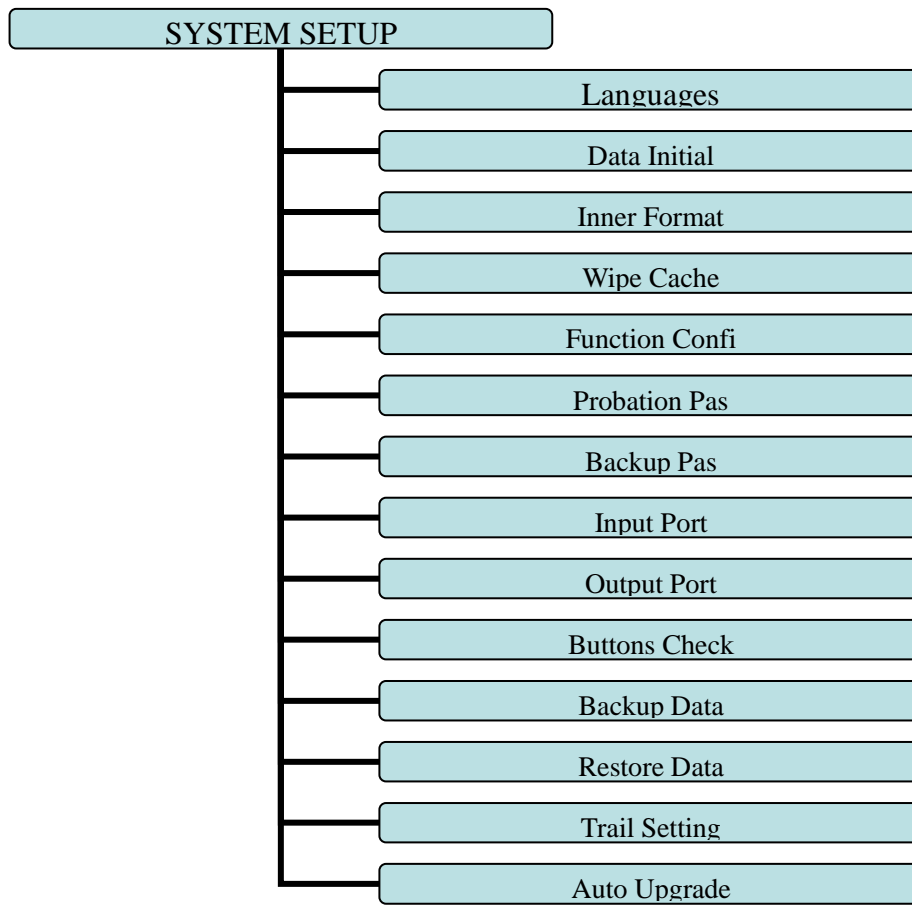

1. Languages

Change system display language, users can choose Chinese and English.

2. Data Initial

After data initial system parameters will restore to factory setting.

3. Inner Format

Wipe the internal files, it will not damage the system parameters.

4. Wipe Cache





Users need to do this after functional upgrade, such as change four-axis program to three-axis program, users must do this operation. After this operation, users need to restart the system.

5. Function Confi (Function Configuration)

Set whether the system retain a function or not, change it according to the actual application in accordance with the practical application of changes. After the operation users need to restart the system.

Set function	
PausePkup	NoPick/Pickup
ScaleFast	None/Affect
Manual	Step/Trad
Preirt	Parse/None
QuryPara	Query/None
StrtHome	Query/Auto/ZOnly/None
CopyWork	Off/On
RetOrgPZ	Pick Z/Z Stop
TolstAct	Pickup/Origin
PauseRstr	All/only Z

CAUTION: Blue parts indicate system default function.

Setting: Press “” / “” move cursor to where users want to modify, press “”, and then select the function users want, press “” to save.

6. Probation Pas (Probation Password)

If engraving machine manufacturers setting some kinds of passwords before shipment (including probation password and backup password, etc.), if you forget the original password, you can connect our company and tell us 20-digit here, our company will provide you a new

20-digit password, you need enter the new 20-digit password, and then all the passwords will be cracked.

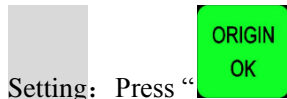

Setting: Press “ORIGIN OK” to enter “Probation Password”, input the new password, and then

press “ORIGIN OK” to save.

7.Backup Pas (Backup Password)

Prevent users overwritten the original correct parameters in the parameter backup disorder or misuse case. To cancel, you do not input any number when you are prompted to enter a new

password, press “ORIGIN OK” to save.

8.Input Port(Input Port List)

1-3:X,Y,Z home signal 4: Tool setting input signal

5-8:Driver alarm,Hard limit,E-stop,pedal switch signal

9.Output Port(Output Port List)

1: Spindle On/Off signal 2-4: Spindle speed signal 5: Alarm indicator signal

6: Work indicator signal

10. Buttons Check

Users can check buttons are valid or not under this menu.Enter “Buttons Check”, press every

button, if it is valid, the screen will highlight.Exit“Buttons Check”, press “ORIGIN OK”+“STOP CANCEL”.

11. Backup Data

Backup system parameters to U disk or inner, format system can't effect this.File format:
[data.bak](#).

12. Restore Data







Restore backup data from U disk or inner to system.

13. Trial Setting

Including Four levels password, password and using time can be set in every level respectively. Password can be setted to be 1-8 digits;using time unit: hour, system default 1.The

password work according to top-down order, if you do not set trial 1 password,only set trial 2-4,it will work according to 2-4 order.

The operation of Data Initial,Inner Format,Wipe Cache should not crack the password.

Setting: Press “” to get into “Probation Set”, press “”, “” to move cursor to which you want to choose.Press “” to get into, and then press “”, input the new number, press “” to save.The screen displays:

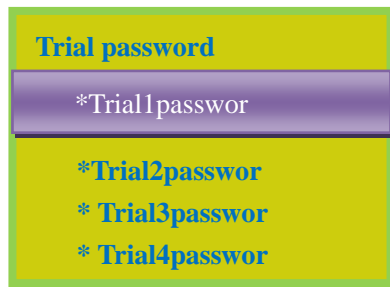

There is a mark “*” before every level password, if not, the password will not work normally.

If you have setted all passwords, press “”, the screen will display:

You must restart the system after setting trial password.

When password expires, the screen will display:

The system is out of testing time,please contact the factory to get more testing time or unlock!

Connect engraving machine manufacturers to get password,press “”, the screen will display:

Please input trail 1 password:

ORIGIN
OK

Enter the password,press “ ” to save. The screen will display:

The time password is updated successfully,please restart the control system.

Restart the handle, and system will work normally.

NOTE: If engraving machine manufacturers forgot all password, you can contact our company and tell us 20-digit original password under “SYSTEM SETUP-Probation pas”, we will

ORIGIN
OK

provide the new 20-digit password, entered the new number, and press “ ” to confirm.

After Cracking Password, restart the handle, and then you can work normally.

14. Auto Upgrade

If the system has new function, our company will provide upgrade file (extension *******.PKG** & shown as **rz-xxxx**), users can upgrade through the U disk, specific steps in Appendix 1. It will not damage the original parameters.

File fomate:  P1_1025(普通三轴雕刻[3寸单色屏][USB1]).pkg

 A11三轴雕刻[3寸单色屏][USB1](q13-378).pkg

4.2.4 OPERATE FILE

Operate File Chart

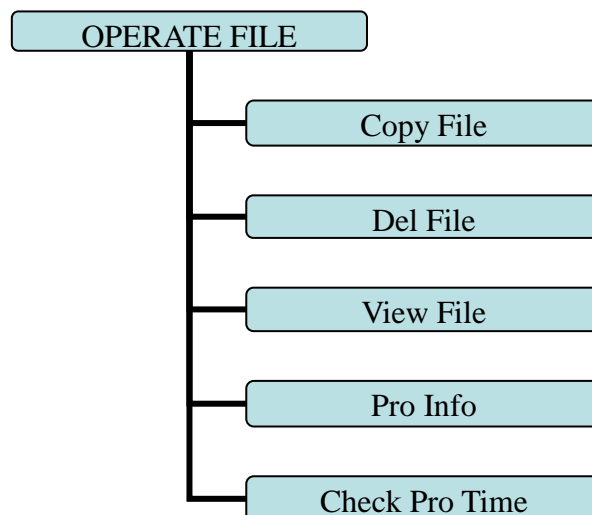

1. Copy File

Copy files from U disk to Inner.

2. Del File (Delete File)

Delete files of inner.

3. View File



View the files and G codes of U disk or inner.



4. Pro Info (Processing Information)

System power on, it will statistical the times of successful processing by file name, if system power off, the data will disappear.

5. Check Pro Time (Check Processing Time)

Calculate processing time by system work speed, after reading G code, the screen will display the processing time, different work speed corresponding to different processing time.

Operation Method: Press “”, enter “Check Pro Time”, press “”/“” to

select “Udisk/Internal/Recent File”, press “” to enter, and then select the file, press “”, after reading G code, the screen will display the processing time.

CAUTION: Please pull out the U disk correctly after copying files from computer, if not, the controller may not recognize the U disk.

1) Win7(32 bit) system: after copying files, please press “”, and then the display will show

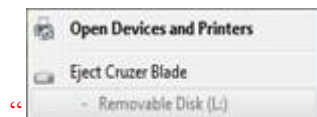

“”, choose the device to be shut down. when the display shows:



“”, the U disk pull out from computer successfully.

2) Win XP system: after copying files, please press “”, and then the display will show

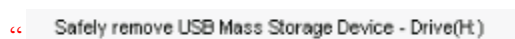

“”, choose the device to be shut down. when the

display show “”, the U disk pull out from computer successfully.

4.2.5 VERSION VIEW

Users can view information about the system hardware and software, including:

Update Version eg: P1.409/rz-xxxx/q10-82

Product ID eg: A0020112

Soft Version eg: A1.1936

Emergency Version eg: A1.1920

Soft type: 3-axis carving **Hardware type:** Support 3-inch screen Support Flash Disk Mode

5. Machine Operation

5.1 Return home

It will display “**all axis home**”, “**Z home only**”, “**none axis home**” after starting up the DSP handle. Choose any one you want. Machine return home can correct the coordinate of system.

In some cases, such as after normal power off, reboot and continue last operation, user no need to reset machine, just choose “**none axis home**”. That is because system auto save coordinate value when system quit.

5.2 Import processing files

Before processing, generally we should import files. RichAuto system has 2 ways for processing: U disk file processing, inner file processing.

1. Directly import the processing file into U disk, then run the handle.
2. Copy the process file to inner memory space via U disk.

5.3 Manual operation

Manual Processing Operation refers to controlling of the machine tool through keyboard. User can change the operate speed and set the grid under manual processing operation. System will enter Manual Operation state after returned home, and the screen displays:

Manual control state initial interface:

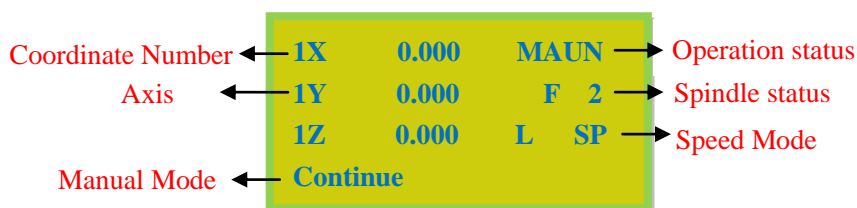

5.3.1 Manual speed switching and adjusting

1) Speed mode switching







There are two speed modes: high speed and low speed. We can change mode by press

“” . The speed mode you choose will decide the processing speed.

2) Speed adjusting

In manual mode, press “” to set the current speed mode. If the current speed is low speed, it displays as follow:

Manual Param	
XSLow	1200.000
YSLow	1200.000
ZSLow	1200.000
SlowGrid	0.100

Press “”、 “” to move the cursor, then press “” button to modify the value, press “” to save, press “” to quit. If input a wrong number, press “” to delete the last number.

In order to ensure the accuracy of processing and debugging, the system introduces the concept of grid which also called minimum feed. Its range is 0.05mm-1.0mm. When user change mode to “step”, machine will move by grid distance.

High speed mode setting is the same as low speed mode.





5.3.2 Manual mode

In order to meet different situation of manual movement, the system provides 3 kinds of motion

modes: Continue, step, distance. We can change mode by pressing “” and the bottom of screen will display what the current manual mode is.

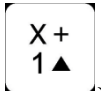
1) Continuous motion mode

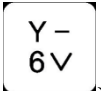
This mode has no value control. In continuous mode, machine will follow when press the

direction button       .Its motion speed is decided by current speed mode.





NOTE: If users release the button immediately after pressing the button(shorter than 0.5s), machine will automatically move to the nearest grid point. It always stop on grid point when the motion mode is over.Continuous mode suitable for crude regulation of machine coordinate situation.

2) Step motion mode

This mode is always move in low speed, move 1 grid per 0.5 second. The grid distance is decided by current speed mode. This motion mode is suitable for tool adjusting or precise adjustment of the location of the mechanical coordinates.

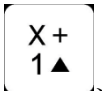
3) Distance motion mode

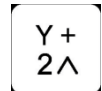
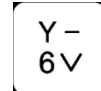
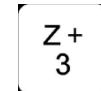
In this mode, it runs according to the setting of distance. Machine will move by the set

distance when user press direction button       .

NOTE: Grid unable to affect the distance motion mode. Machine will move by set distance, can't move to grid point. If user wants to change distance, please change to distance mode and re-enter the distance value.

5.3.3 Manual testing input and output

In the initial boot interface, that is screen displays as follow:

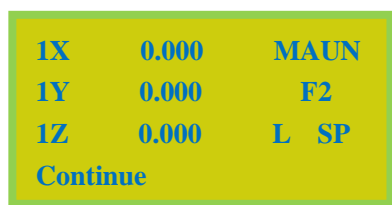

Press “”twice, the screen will displays two rows of arrows which are defaults to all arrows are downwards “↓”.

Upper arrows represent input signal: the former 4 numbers 0, 1, 2, 3 corresponding to X,Y,Z home and tool setting signal. 4,5,6,7 corresponding to driver alarm,hard limit,E-stop and pedal

switch signal.

Manual trigger the corresponding signal switch,if the corresponding arrow flip so,the signal is normal.If not,please check corresponding switches or 50-pin cable and interface board.

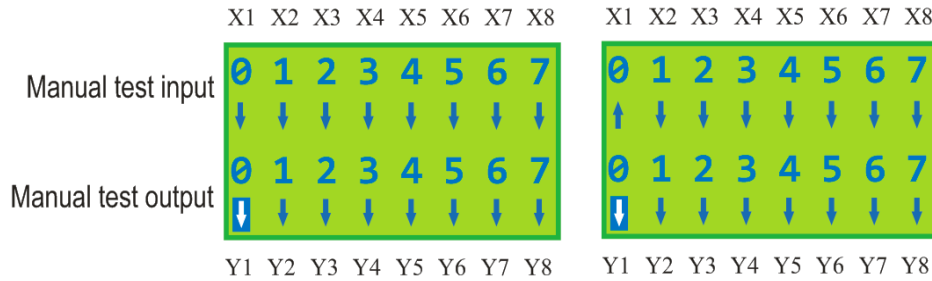

NOTE:Different from Voltage Setup.

Bottom arrows represent output signal: the former 4 number 0,1,2,3 corresponding to spindle on/off、 spindle speed 1-3.4,5 corresponding to alarm indicator, running indicator.

Press “” button can change the arrow direction, so it can control the output of

corresponding interface. For example, press “”to flip the arrow upwards under 0, it is

equivalent to start the spindle. Press“” again, the arrow flip downwards that is equivalent to stop the spindle.

5.3.4 Manual switching coordinate system



Including **machine coordinate system** and **work coordinate system**.

Machine coordinate system is fixed, the origin of coordinates is always a fixed position relative to the machine; Its coordinates is called mechanical values, the origin of coordinates is the origin of the machine or reference point. so that at any time, one point of space can be confirmed by machine coordinate system. Because of reference point is the calculation basis of machine coordinates movement, powered on or remove all abnormal states , you need back to zero.

Work coordinate system used more greatly than other coordinates system in processing.Usually in processing, we describe a processing position is always relative to a certain point on the workpiece, whereas the workpiece on the machine tool's position relative to the mechanical origin is often change, so it is necessary to introduce a set of more convenient coordinate system during processing, this is work coordinate system.The origin of work

coordinate system is a fixed point relative to the workpiece, but relative to the origin of machine coordinate system is floating.

RichAuto-A1X provide a machine coordinate system and nine work coordinates system,

press “” + “” can switch machine coordinate system and work coordinate system,

“” + “NO.button1-9” can switch machine coordinate system and eight work coordinates system.

Coordinates system:

AX	0.000	MAUN
AY	0.000	S 2
AZ	0.000	L SP
Continuous		

1X	0.000	MAUN
1Y	0.000	S 2
1Z	0.000	L SP
Continuous		

Machine coordinate system

Work coordinate system1

2X	0.000	MAUN
2Y	0.000	S 2
2Z	0.000	L SP
Continuous		

9X	0.000	MAUN
9Y	0.000	S 2
9Z	0.000	L SP
Continuous		

Work coordinate system2

... Work coordinate system9

NOTE: You can not set work origin under machine coordinate system, switch to work coordinate system to set work origin.

5.4 Automatic processing operation



Auto processing refers to the system runs the file in U disk or inner storage space according to the instruction, it also called file processing. Before auto processing, user must set the machine tool parameters and all of the system parameters correctly.



Auto processing steps as follow:

5.4.1 Set workpiece origin

The origin coordinates of X, Y and Z in the processing program is the origin of the workpiece . Before operation, we should pay attention to this position as well as the real position. Operation is as

follow:



Move X,Y and Z to the position which will start to process the file on workpiece. Afterwards, press zero clearing “” can set the origin of X,Y axis. Press zero clearing “” to set the origin of Z axis. It should be noted that if user have already used the tool setting function which



combination button is “”+“”, will no need to press the “” button.

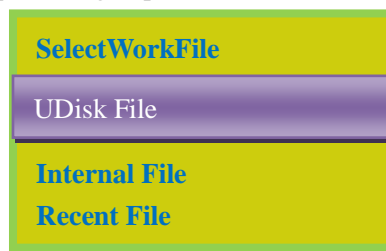

5.4.2 Choose processing file

After determined the workpiece origin, press “” will appears a dialog frame:



Press “”、“” to move the cursor and choose, press “” to enter into the list,



the screen will display three file name, choose the file by pressing “”、“”. Press

“”、“” to turn to the next page. Press “” to exit.

5.4.3 Set processing parameters

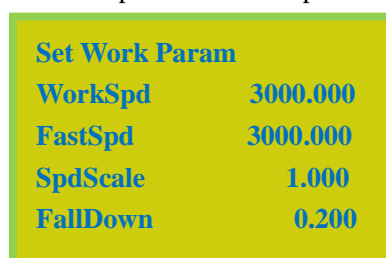
After choosing the processing file please press “”, enter into processing parameters setting, it includes work speed、 travel speed (or Fast speed) 、 speed scale(speed ratio)、 fall down speed(or Z down ratio).



Press “” and “” to move cursor, press “” to set the value (next value

setting is the same as this one), then press “” to save, the system will check the processing code and start to process when checking finished.

The system code checking is auto mode, user can press “” to skip the checking and start running file immediately.





System will remember the checking only when the previous checking is a complete and correct checking. So that the system will not check the same code again next time.

In the process of processing, the screen scrolling display real-time processing speed, operation time, current line number. We can switch these options by pressing “”.



5.5 Operations during processing



5.5.1 Speed ratio & spindle grade Adjusting

1) Adjust speed ratio

In process of processing, press “”, “” can directly change speed ratio, current speed = set speed * ratio, each push on “” or “”, the speed ratio will go up or down drop 0.1. Speed ratio: max 1.0, min 0.1, the displayed speed will corresponding to the changing of speed ratio, but time will not change.

2) Adjust spindle grade

If user has set multistep speed, the DSP handle can change the multistep speed in process of processing. Press “” and “” to change spindle grade.

Each push of “” and “” will go up or down drop 1 grade till to S8 or S1.

5.5.2 Pause & adjust position

Press  pause processing. The right upwards of screen will change from“MAUN”

to “PAUZ”and machine paused processing except the rotating of spindle. Shown below:

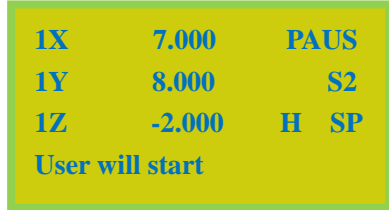



At this moment, the user is allowed to adjust the position of X, Y and Z axis. The system default motion mode is STEP. So that user can fine adjust each axis distance. Machine moves one low or high speed grid distance every step. Meanwhile, user can change the speed mode to high

mode just press .

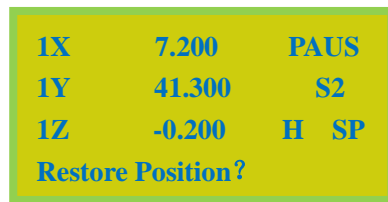
When the adjustment is finished, press  again, screen shows below:



The system asks the user whether save the modified position. Press / 







the system will start processing in modified position, press , system will back to the position before modifying.

5.5.3 Breakpoint processing & power down protection

1) Breakpoint processing

If user presses  during process of processing, the screen shows below:



If we want to save breakpoint, press “”, the screen displays break list (totally 8), press “”、“” to choose the save position and then press “” to save, system auto go to standard interface. If we want to continue processing from the breakpoint, we can choose the combination button “” + “1-8”. First press “” and not release it, at the same time press number button (1-8), then release together, the system will start processing from the breakpoint.

For example: You want to start processing from the breakpoint 1, then you should use the combination button “” + “1”, system will restore processing from breakpoint 1. The screen shows below:

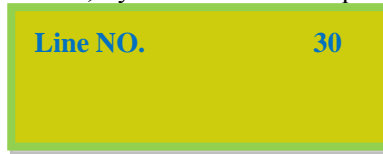

If you want to go backwards from this breakpoint, press “” and input the line No.,

and then press “”, system will work from the new line number.

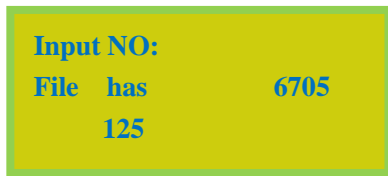

2) Power off protection

When there is a sudden power failure during processing, system will save current coordinate and parameters, while power restart, process continue. Before that, system must have a home motion. Shown as below:

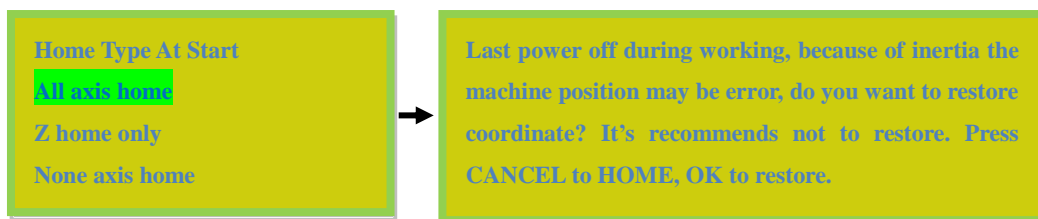



Press “” to continue unfinished processing, it will display stop line No, and the line





number can be chosen. Press “” cancel the power off protection.

5.6 Advanced Processing

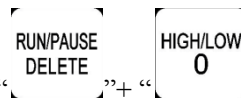
Advanced processing is designed for some special requests, it contains: Array work, Resume work, Tool changing, Part work, Calculate bound, Mill plane, step work file, Calculate work time,





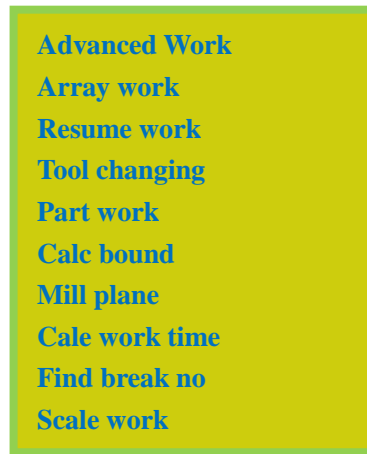

Find break NO. The combination button is “”+ “”, shown below:





5.6.1 Array work

Steps as below:

1) Press “”, “” to move cursor to the Array work, press “”, press

“” or “” to select different files list.

2) Press “” to enter file list, then press “”, “” move the cursor to choose object file.

3) Set processing parameters, also can modify the array parameters in this step, or you can go to “AUTO PRO SETUP”, choose “Work Array” and modify the array parameters. The rest steps are similar to the normal processing. System will start to work according to the user’s setting.







4) In the processing of array work, you can view current row number, volume number etc. by



pressing “”.

CAUTION: Set interval to a negative value if users want a manual control during array processing.



5.6.2 Resume work

Steps as follows:

Press “”, “” to move cursor to resume work, press “” to enter, then press “” or “” to select different break points, and then press “”, system will restore processing from the break point. **If you want to go backwards from this breakpoint,**



press “” and input the line No., and then press “”, system will work from the new line number. **Specific operation steps in 5.5.3 breakpoint processing & power down protection.**





5.6.3 Tool changing









It achieve manually change the tools at the position you set. Press “” to enter into the setup, and also press “” back to work origin.

5.6.4 Part work

Part work means user can select start line and stop line, so part of the processing file can be processed. Steps as follows:







1) Press “” to set, press “” and “” to move the cursor to select different file list;

2) Press “” to enter, press “” and “” to select a file, then press “”, system start to read the file.

- 3) After read the file, press “” the screen display line 1 of the code, press “”, prompted “input start number: displays total lines”, input number of start line and press “” to confirm, if input wrong number, just press “” to delete it.
- 4) Press “” again, to set the end line, the screen displays “input end number”, press “” the screen save the changed start line number, press “”, Input end line in cursor, press “” to confirm, press “” to modify.
- 5) Set processing parameters.

5.6.5 Calculate bound

Calculate bound means user can check the size of processing, So as to avoid unnecessary waste of materials and processing errors. Steps as below:







- 1) Press “” to enter, then press “” or “” to select file list;
- 2) Press “” get into the file list, and then press “” or “” to choose file.
- 3) Press “”, system start to read the file, after reading the file, the system will calculate the area.

5.6.6 Mill plane

Include two types: scan mill and encircle mill.







1. Scan mill

Scan mill set	
Scan type	X Scan
Width	100.000
Height	100.000
Diameter	10.000
Depth	0.100
Z Step	0.100
T Ratio	0.800

- 1) Press “” or “” to move cursr to choose the mill type.
- 2) Press “” to enter the scan mill set, it includes: Scan type, Width, Height, Diameter, Depth, Z Step, T Ratio.
- 3) Press “” and “” to move cursor on the option which need modify, press “” to choose mill type(X Scan or Y Scan), also press this button to modify the parameters. Press “” after modified all the parameters to save them.

2. Encircle mill

Scan mill set	
Scan Type	AC
Width	100.000
Height	100.000
Diameter	10.000
Depth	0.100
Z Step	0.100
T Ratio	0.800

- 1) Press “” or “” to move cursr to choose the mill type.
- 2) Press “” to enter the scan mill set, it includes: Scan type, Width, Height, Diameter, Depth, Z Step, T Ratio.
- 3) Prss “” and “” to move cursor on the option which need modify, press “” to choose mill type(AC or C), also press this button to modify the parameters.
Press “” after modified all the parameters to save them.



5.6.7 Calculate work time

Calculate the processing time according to the system processing speed. After pre-read



processing file, the system will display total processing time. Different processing speed will correspond to different processing time.

5.6.8 Find break no

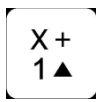
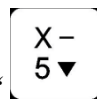
If fail or forget to save the breakpoint, but not change work origin, after changing new tool,

users can choose this operation. Move X, Y axis to the processing stop position, press “” + “” to start “Advanced Work”, and then press “”, “” to choose “Find break



no.”, press “” to get in, after reading, screen shows: Press enter key to continue working from searching position, press other key only show the line number.

Press “” to start processing, press “ ”, the screen will show the line number.

CAUTION: Work coordinate system must be same to the coordinate system which saves the breakpoint.

Look for position line number. If accidentally cutter break and user hasn't saved the break point, reboot system and replace the cutter. After that, user can manually move X, Y axis to the

nearest point where the cutter was broken (recommend to move a little further), press “” enter into “Find break no.”, afterwards choose the previous processing file, the system will prompt “searching current position”. System will start processing after finished the searching, the system

will prompt “press “” start processing, press “” to view the current position of line number”.

5.6.9 Scale work

If the actual processing requires different sizes of the same file, you can select the **scale work**, you need to enter an enlargement or reduction ratio for processing.

Steps: Press “” to get in “Scale work”:

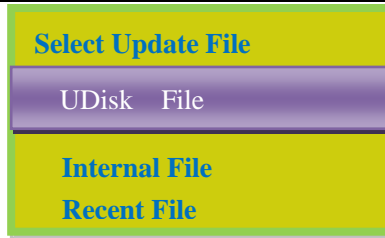

Choose Processing file, input correct parameters:

Scale	work	param
X	scale	1.000
Y	scale	1.000
Z	scale	1.000

and then press “” to start processing.

6. A12--Plasma Cutting Motion Control System

6.1 Handle and buttons introduction

One-touch button and Combination button are same to A11, and the shell color of A12 is brown.



Handle

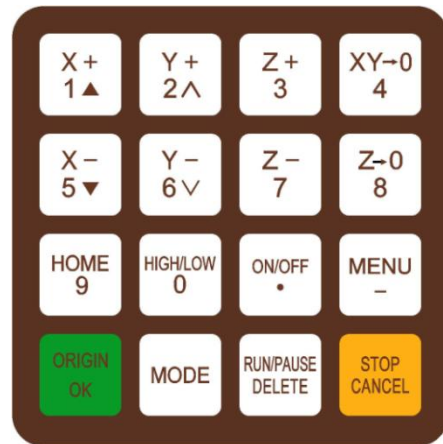

Buttons

	Function
	Arc On/Off, decimal point inputting

The handle and interface board of A12 make special anti-interference, which make system work normally during strong interference.

6.2 Output description

OUTPUT SIGNAL

	Function	Notes
Y01	Plasma arc control output	Logic low, control arc&cylinder
Y02	Cylinder Delay output	Up&down delay

6.3 Arc setup&wiring

2-axis setting

- 1) MENU-MACHINE SETUP-Home Setup-Home Order-XY home
- 2) MENU – AUTO PRO SETUP –Safe Height-Set 0

OUTPUT SIGNAL

2-axis with cylinder delay

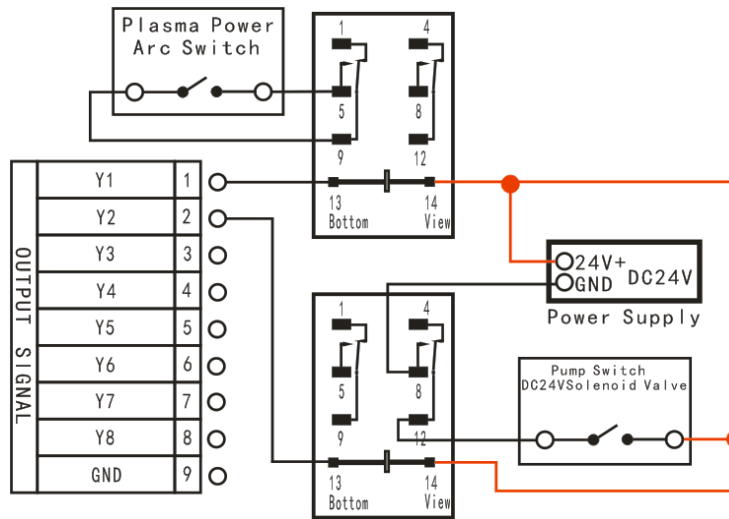

1.2-axis

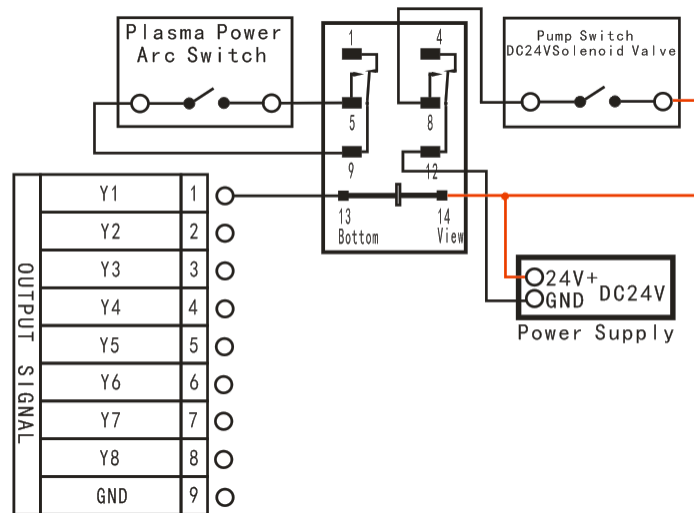

2.3-axis

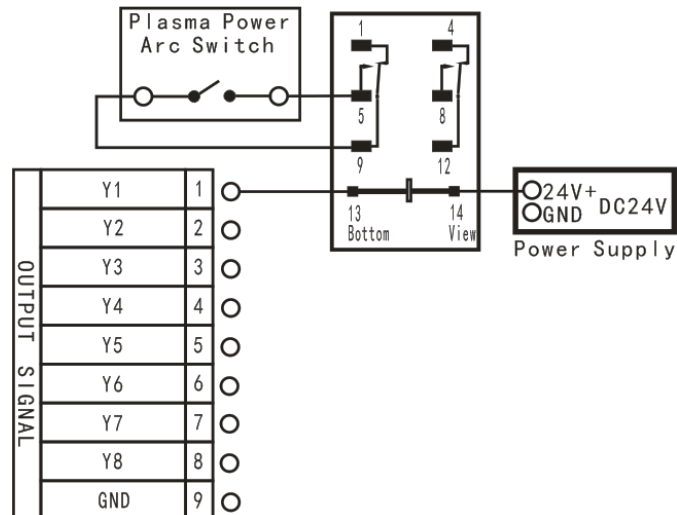

6.4 Parameters description

1. Axis Prohibited (MACHINE SETUP)

If it is a two-axis plasma cutting machine, users can choose to set t Z-axis disable, and all relevant parameters about Z axis will no longer be meaningful.

2. Arc Delay (MACHINE SETUP) Unit: ms

OnDelay: How long to wait for starting plasma after reading file.

OffDelay: How long to wait for closing plasma after processing.

3. Cylinder Delay (MACHINE SETUP) Unit: ms

DwnDelay: How long to wait for cylinder getting down.

UpDelay: How long to wait for cylinder rising up.

4. Circle Limit (AUTO PRO SETUP)

System default 1000 (not speed unit) . If small circle processing speed too fast that cause deformation or bad quality,users can reduced this value proportionately, such as 500,250,125 ...,and it can greatly improve the quality of processing.

5. Plasma Config (AUTO PRO SETUP)

PreOnDly: How long to wait for cylinder getting down.

PreOfDly: How long to wait for cylinder rising up.

7. A15--Multi-spindle Motion Control System

7.1 Handle and buttons introduction

The color of A15 handle is brown:



Handle

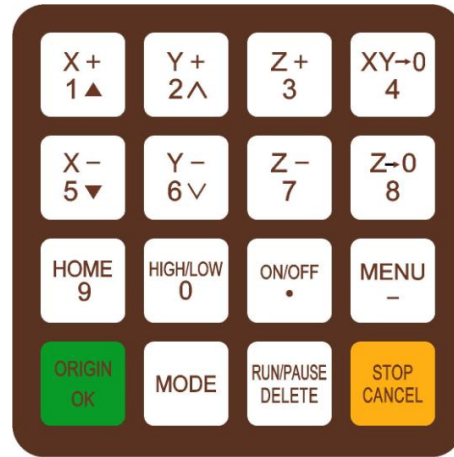

Buttons

Special combination button

	Combination button	Function
1	 “ ON/OFF ” + “ HIGH/LOW ”	Cylinder change over
2	 “ RUN/PAUSE DELETE ” + “ ON/OFF ”	Calculate Z axis offset value of each tool

7.2 Output description

OUTPUT SIGNAL

	Function	Notes
Y5	Cylinder 1 output	Logic low, control spindle 1 up and down
Y6	Cylinder 2 output	Logic low, control spindle 2 up and down
Y7	Cylinder 3 output	Logic low, control spindle 3 up and down
Y8	Cylinder 4 output	Logic low, control spindle 4 up and down

7.3 Spindle wiring

1.Count 1(Spindle On/Off): One spindle with one inverter, spindle 3,4 same as 1,2.

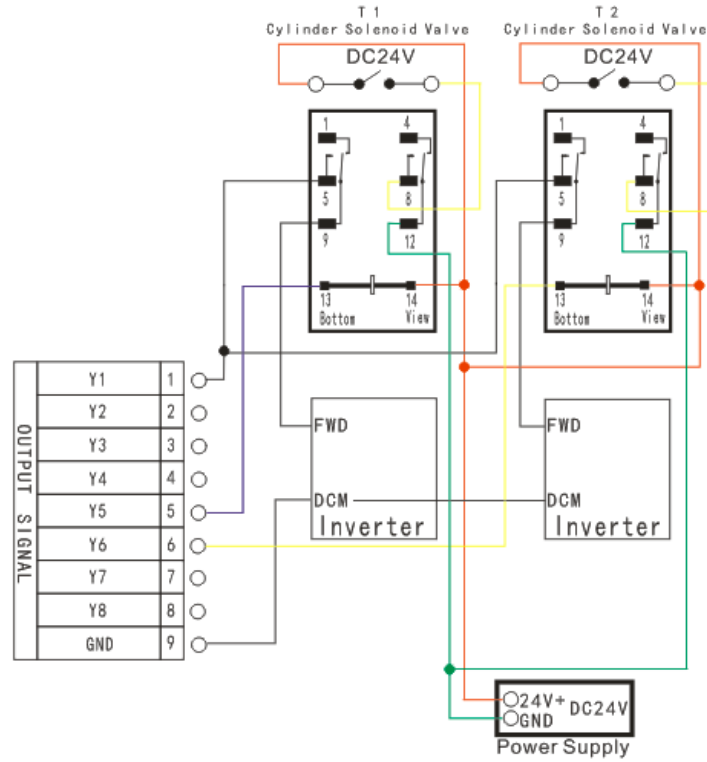

2.Count 3,multi-speed: One spindle with one inverter, spindle 3,4 same as 1,2.

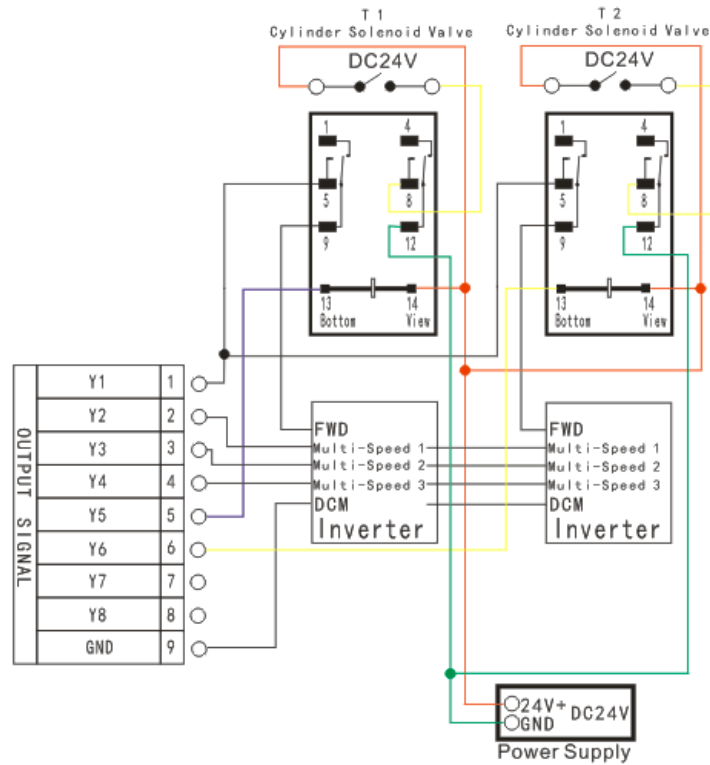

3. Two spindles with one inverter

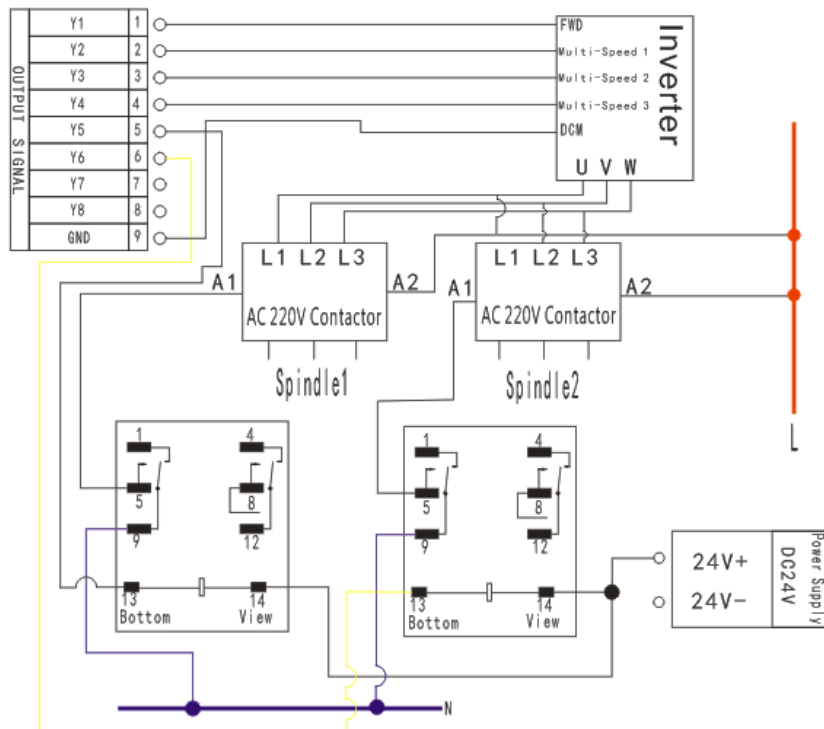

7.4 Multi-spindle setup



1. Tool Setup: (MACHINE SETUP)

Tool Count: Input spindle count, Max 4.



Offset:



a) Offsets of X,Y:

1) Input by measuring.

2) Chuck every spindle with sharp tool, press “” + “”, switch to spindle 1

and then press “”. Move Z axis to the surface of workpiece to drill a small hole. Press



“” ,clear the coordinate values of X,Y axis to zero. Press “” +

“”, switch to spindle 2, and then press “”. Move Z axis to the small hole,

now users can see the coordinate values of X,Y axis on the screen, the values are the offsets of



spindle 2(note that positive or negative).



Same to spindle 3,4.

  **Steps:** Press “” to get in “Tool Setup”, Screen displays “Press OK key to set tool offset by manual mode,it’s very simple but not accurate,press cancel to set by number.” ,and then

press “” , the screen shows :

Spindle Offset of 2	
X axis	0.000
Y axis	0.000
Z axis	0.000

Press “”/“” to move cursor to where users want to modify,and then press





“” , input the new number, and press “” to save.



After setting spindle 2,press “” ,the screen will show the interface of “SpindleOffset of 3”,same to spindle 4.

b) Offset of Z:



1) The machine is not equipped with C.A.D(Tool sensor)

Firstly, get in “SYSTEM SETUP-Function Confi-ToolSet”,choose Maunal.

Press“”+ “” ,switch to spindle 1, and then press“”+ “” ,





press“” to move Z axis to the surface of workpiece,and then press“” ,system will automatically switch to spindle 2,repeat the same operations to calculate all offsets.

After calculating all offsets, choose anyone of the spindles to set work origin,also press

“” and “” to confirm work origin.System will automatically confirm the work origin of the other spindles according the offsets.



2) The machine is equipped with C.A.D(Tool sensor)

Firstly, get in “SYSTEM SETUP-Function Confi-ToolSet”,choose Atuo.

Press “”+ “”,switch to spindle 1, and then press “”+ “”,

system will automatically move Z axis to the surface of C.A.D(Tool sensor),after touching the surface,system will automatically switch to spindle 2, repeat the same operations to calculate all offsets.

After calculating all offsets, choose anyone of the spindles to set work origin,also press

“” and “” to confirm work origin.System will automatically confirm the work origin of the other spindles according the offsets.

2.Cylinder Delay: Unit: ms (MACHINE SETUP)

Time of waiting cylinder rising or falling finished.

7.5 G code example







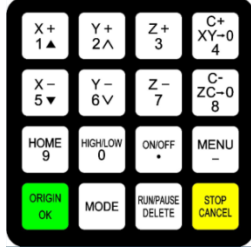

```
T1 (Switch to spindle 1)
M03 (Spindle 1 CW)
G00 X20 Y20 Z0
G01 X20 Y20 Z-2
G01 X120 Y20 Z-2
G01 X120 Y120 Z-2
G01 X20 Y120 Z-2
G01 X20 Y20 Z-2
G00 Z20
G00 X20 Y20
M05 (Spindle 1 Off)
```

```
T2 (Switch to spindle 2)
M03 (Spindle 2 CW)
G00 X2 Y2 Z0
G01 X2 Y2 Z-2
G01 X12 Y2 Z-2
G01 X12 Y12 Z-2
G01 X2 Y12 Z-2
G01 X2 Y2 Z-2
G00 Z20
G00 X2 Y2
M05 (Spindle 2 Off)
```

T3,T4 same as T1,T2, the last line of the program can choose to write M30-- end of program,and return to program top

8. A18--Four-axis Linkage Motion Control System

8.1 Handle buttons introduction

	Combination button	Function
	 + 	Set X axis and Y axis work origin
	 + 	Set Z axis and A axis work origin
 , 		Positive movement of A axis, figure 4 inputting Negative movement of A axis, figure 8 inputting
		Enter menu setting, negative sign inputting, check information during processing

8.2 Input description

Port lable	Port definition	Signal description	Pin functions and parameters	Notes
INPUT SIGNAL	X01	X Machine zero	Logic low	For external connection with mechanical, photoelectrical or proximity switch
	X02	Y Machine zero	Logic low	For external connection with mechanical, photoelectrical or proximity switch
	X03	Z Machine zero	Logic low	For external connection with mechanical, photoelectrical or proximity switch
	X04	A Machine zero	Logic low	For external connection with mechanical, photoelectrical or proximity switch
	X05	Tool setting	Logic low	
	X06	Driver alarm	Logic low	
	X07	Hard limit	Logic low	
	X08	E-stop	Logic low	

8.3 Parameters description

1.Pulse equiv: Unit: ms (MACHINE SETUP)

Rotation axis stepper driver: Formula = pulses per revolution / angles per revolution (360°)



$$\text{pulse} = \frac{360^\circ}{\text{stepper angle}} * \text{driver subdivision} \\ 360^\circ * \text{transmission ratio}$$

Rotation axis servo driver: Handle pulse equivalent(400)*360* mechanical transmission ratio

2.Work Orig Offset: (Auto Pro Setup, Unit: mm)

It is mainly used for the work origin position which is the center of the processing material. If the processing material is cylindrical and work origin is the center, we can still set origin on the surface and then modify work origin offset number for cylindrical radius, so that the actual work origin is the center. X、Y、A are the same.

3.The rotation axis labels: (System Setup - Function Configuration-Rotatamark)

Change the rotation axis marked with A, B, C three markup, the user changes the actual situation, the changes and the need to reboot the system off.

8.4 G code example

G90 G54

M03

G01 X209.5 Y5.684 Z90. A0.0 F3000

X4. Y5.51 Z89.851 A4.708

Y.02 Z23.188

M05

M30





9. Appendix

9.1 System upgrade



Copy upgrade file to U disk, and insert U disk into handle, file format: extension *********.

PKG & shown as **rz-xxxx**.

U Disk Upgrade Method 1

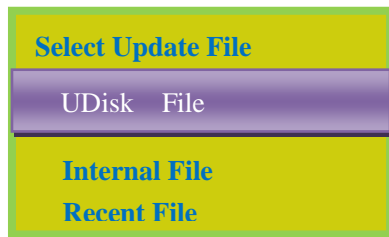
1. Press “”, and then select “System Setup”, press “” to enter, press “”,
/ “”, select “Auto Upgrade”. The screen displays:



2. Press “” to enter, select “Udisk File”, then select upgrade file, press “”,
system will auto upgrade.

3. After upgrade completed, restart the handle.

U Disk Upgrade Method 2

1. Copy upgrade file to U disk, and insert U disk into handle.

2. Press “” + “”, screen display:

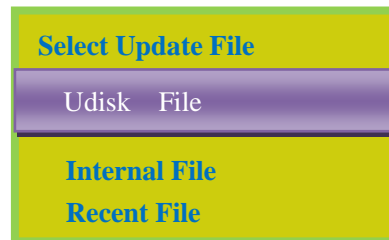



3. Repeat Method 2 operation 1.2&1.3.

9.2 U-disk Function

Users can copy file from computer to handle after “**Product ID:A010XXXX & Update Version rz-1967**” version. Connect handle and computer by USB cable, users can find portable storage device on the computer , and then copy processing files from computer to handle inner. This function can insure that if USB port of the handle is broken or there is no U disk , the machine can still work normally.

Steps:

4. Press any two buttons at the same time (for example: “” + “”).
5. Connect handle and computer by USB cable, it means that the handle is powered by computer, loosen the buttons after the power supply.
6. Handle screen displays:



Connect successfully.

7. Open “My Computer”, and you will find portable storage device:



A0101203(H:) :Handle, Users can copy processing files to handle inner.

8. Connect handle and machine, Choose internal file to start processing.

NOTE: Users can check hardware type in Version View: “FlashDiskMode” is necessary or not ,if not, users can not copy processing files from computer to handle inner.

9.3 Servo driver parameters

9.3.1 YASKAWA Σ -7、 Σ -V

1. Wiring diagram (Y、Z same as X) Set PnA=8170, do not connect pin-40

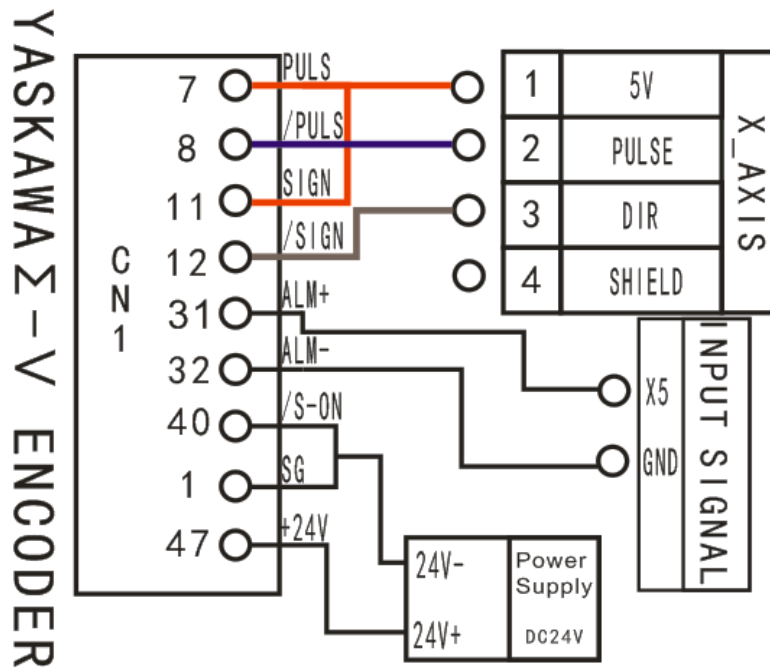

Motor brake:

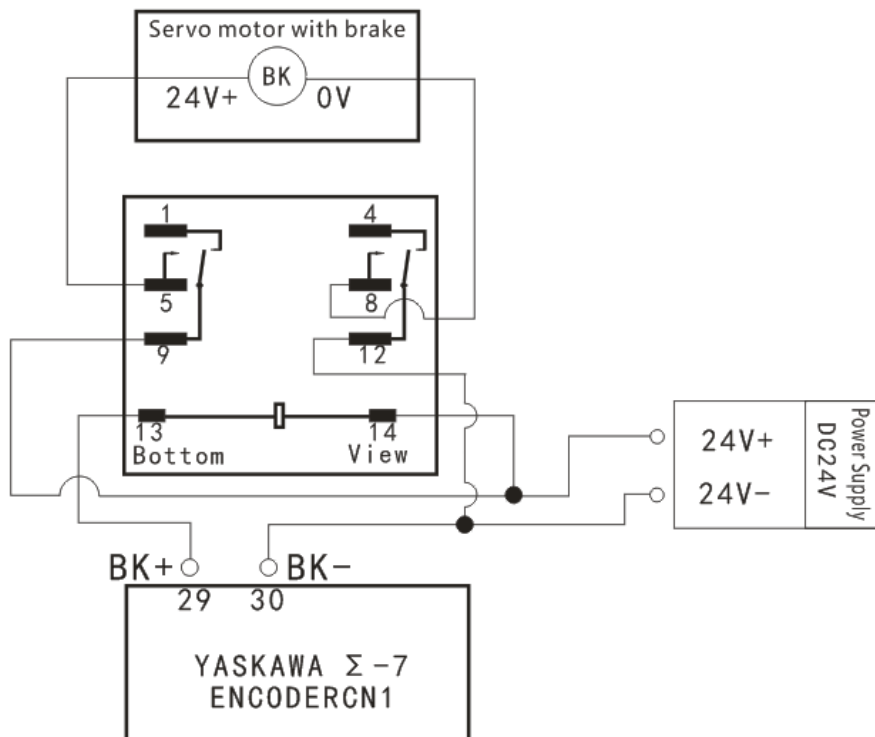

Σ -7 same as Σ -V

2. Parameter setting

Para. No.	Function	Value	Description
*Pn000	Function selection basic switch 0	0010	Bit 0: Set 0, positive rotation at positive rotation command Bit 1: Set 1, position control mode (pulse sequence command)
*Pn200	Format selection switch of position control command	0005	Bit 0: Set 5, select the instruction mode as "pulse+direction", negative logic
*Pn20E	Electronic gear ratio (numerator)	Need calculation	Pn20E = Encoder resolution Pn210 = Pulse equivalent × Screw pitch × Transmission ratio
*Pn210	Electronic gear ratio (denominator)	Need calculation	e.g. Pulse equivalent 1000, Screw pitch 10mm, Encoder 20-bit, Transmission ratio 1 $Pn20E/Pn210 = 2^{20}/1000 \times 10 \times 1 = 1048576/10000 = 131072/625$
*Pn50A	Input signal selection 1	8170	Bit 1: Set 7, servo on all the time. Bit 3: Set 8, positive rotation not used and signal input (P-OT) prohibited
*Pn50F	Output signal selection 2	0300	Set it when servo motor with brakes. Bit 2: Set 3, brake interlock signal "/BK" is output from CN1-29, CN1-30 to control 24V relay used for brake
*Pn50E	Output signal selection 1	0211	Set it when servo motor with brakes. To avoid of CN1-29 and CN1-30 being used for other function and leading to brake ineffective, 3 is not allowed to appear in the 4 digits.

NOTES:

1.

```

... Bit2 Bit1 Bit0
... 0 0 0
    
```

The same below.

 2. For parameters which No. have a suffix of "*", changed contents will be validated when you turn on the control power. **The same below.**

3. ALM+: pin-31, ALM-: pin-32, normally closed. The default alarm input terminal of A11, A12, A15 is X5, A18 is X6.

 Machine Setup-Voltage Setup, modify level of X5 (X6-A18) normally closed (Press "  ")

change the direction of the arrow facing up) **The same below.**

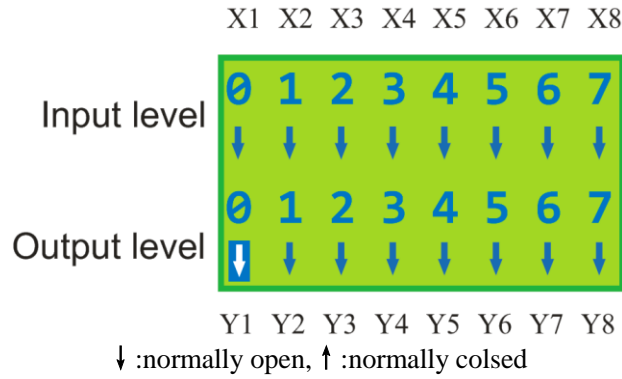

9.3.2 PANASONIC MINAS A5

1. Wiring diagram (Y、Z same as X) Set Pr4.05=8618883,do not connect pin-29

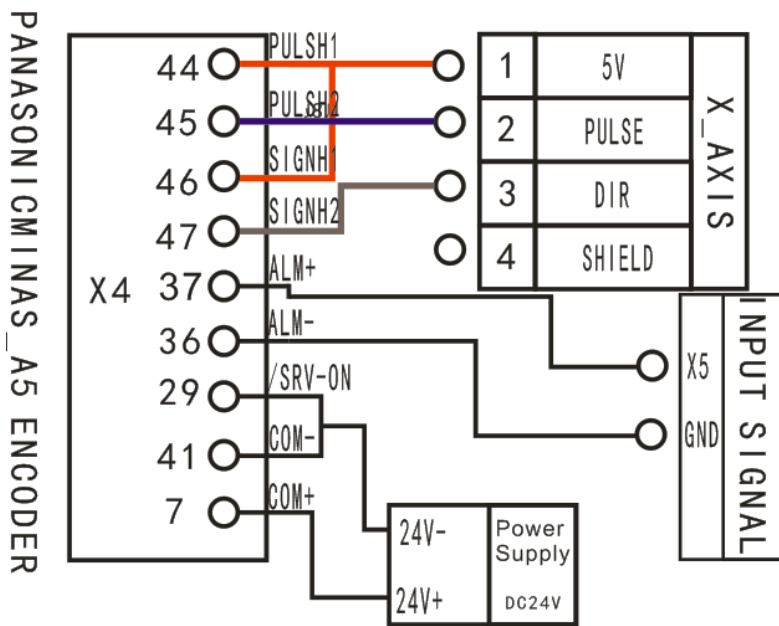

Motor brake:

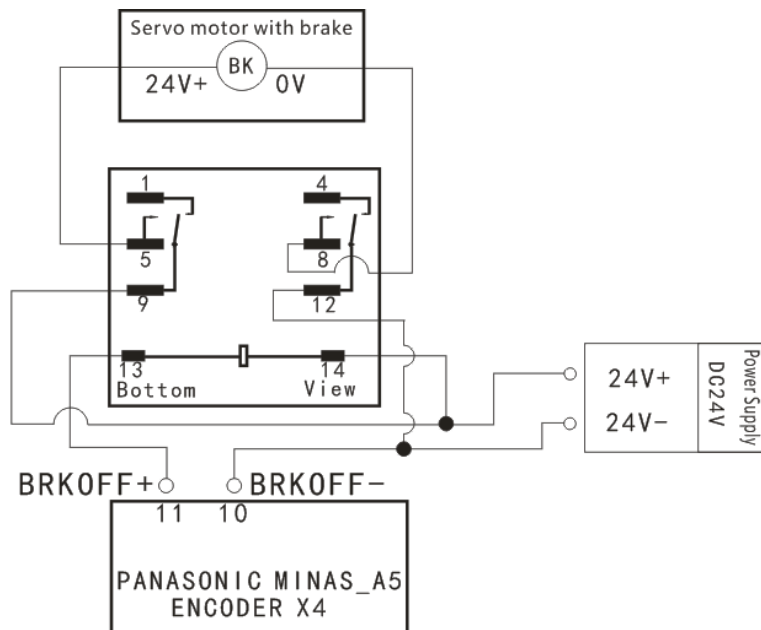

2. Parameter setting

Para. No.	Function	Value	Description
*Pr0.00	Setting the direction of rotation	0	If the motor rotation direction opposite to the actual needs, set 1.
*Pr0.01	Select control mode	0	0:Position mode,1: velocity mode,2: torque mode
*Pr0.05	Selection of command pulse input	0	0:Photo-coupler input (PULS1,PULS2,SIGN1,SIGN2) 1:Exclusive input for line driver (PULSH1,PULSH2,SIGNH1,SIGNH2)
*Pr0.07	Command pulse input mode setup	3	Set command pulse input mode:command pulse+command direction,negative logic.
*Pr0.08	Command pulse No. per motor circle	0	When it is set to "0",parameters Pr0.09 and Pr0.10 are valid
Pr0.09	1st numerator of command pulse frequency multiplication	Need calculation n Range:0~ 2^{30}	Z1 = Encoder resolution Z2 = Pulse equivalent×Screw pitch×Transmission ratio e.g. Pulse equivalent 1000, Screw pitch 10mm, Encoder resolution 10000, Transmission ratio 1 Z1/Z2= 10000/1000×10×1=1/1
Pr0.10	Denominator of the command pulse frequency multiplication	Need calculation n Range:0~ 2^{30}	set Pr0.09=1,set Pr0.10=1. The value of Pr0.09 and Pr0.10 must be integer,range: 0~230 .
*Pr4.05	Function setting for digital input pin SI6	8618883	Bit1,0 :Set 83,servo on all the time.

NOTES:

1. ALM+: pin-37, ALM-: pin-36, normally closed.

9.3.3 DELTA ASDA-A2&B2

1. Wiring diagram (Y、Z same as X) Set P2-10=1, do not connect pin-9

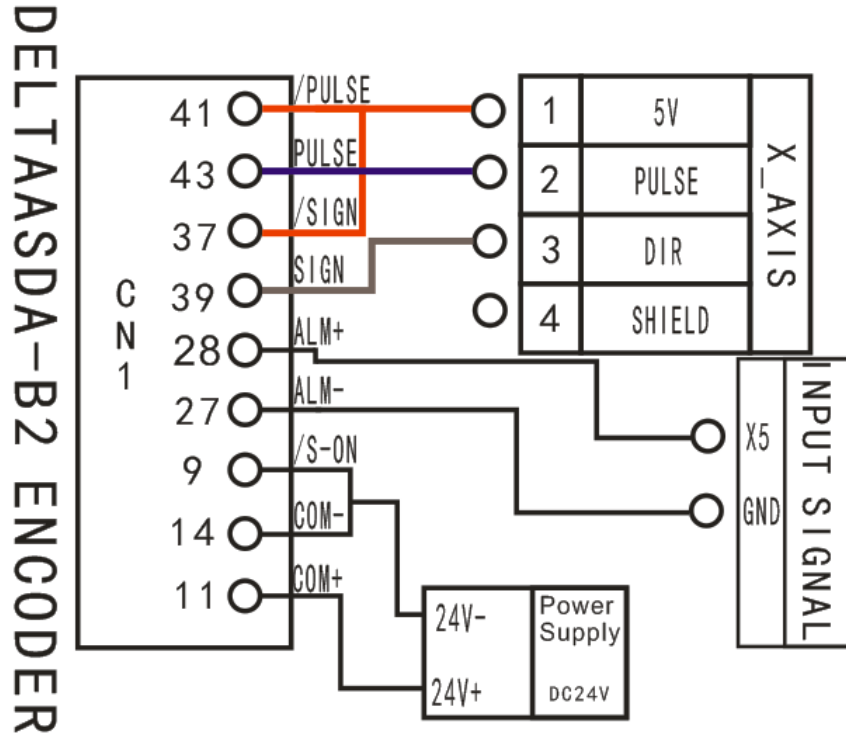

A2 Series PULSE,/PULSE,SIGN,/SIGN correspond pin-43,41,36,37, COM- corresponds pin-45/47/49

Motor brake:

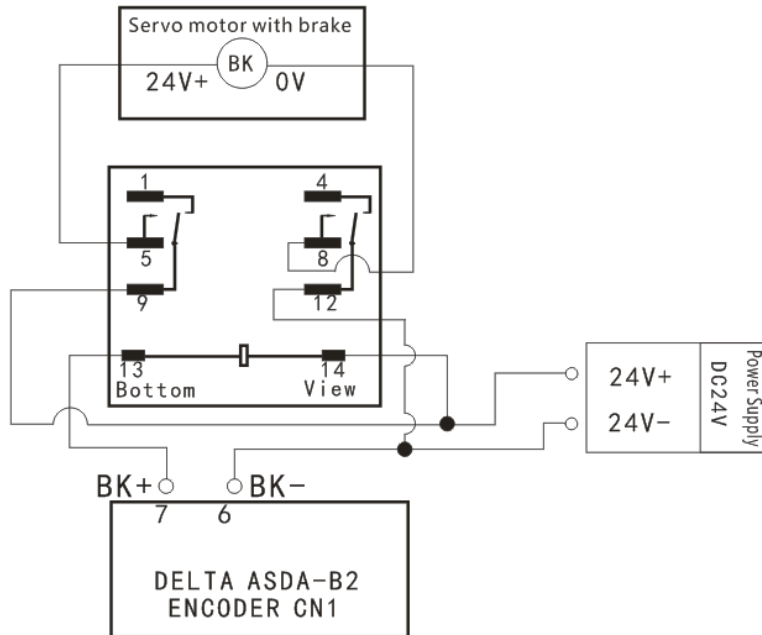

A2 series BK-,BK+ correspond CN1-1,26

2.Parameter setting

DELTA ASDA-B2	Function	Value	Description
P1-00	External pulse train input type	102	Bit 0: 2--pulse+direction Bit 2: 1--negative logic
*P1-01	Set control mode	0000	Bit 3: Maintaining the set value.Since switching control mode is not used,bit 3--0. Bit 2: 0--forward rotation(CCW)(from the view of load) Bit 1,0: 00--position control mode
P1-44	Electronic gear ratio(numerator)(Z1)	Need calculation	Range: 1~32767; Z1 =Encoder pulses×4; Z2 =Pulse equivalent×Screw pitch×Transmission ratio
P1-45	Electronic gear ratio(denominator)(Z2)	Need calculation	e.g. Pulse equivalent 1000, Screw pitch 10mm, encoder pulses 40000, Transmission ratio 1 $Pn1-44/Pn1-45=40000 \times 4 / 1000 \times 10 \times 1 = 160000 / 10000 = 16 / 1$
P2-10	Function setting for digital input pin DI1	1	Bit 0: Set 1,servo on all the time.
P2-18	Function setting for digital output pin DO1	108	DO1 corresponds to pin-6 & pin-7,used as clamping-position brake signal of Z-axis Bit1,0: 08--set pin-6 and pin-7 as BK- and BK+ repectively. Bit2: 0--set DO15 output as normally closed b-contact point
P2-22	Function setting for digital output pin DO5	007	DO5 corresponds to pin-28 & pin-27,used as servo alarm signal Bit1,0: 07--set pin-28 and pin-27 as ALRM+ and ALRM- repectively. Bit2: 0--set DO5 output as normally closed b-contact point

DELTA ASDA-A2	Function	Value	Description
P1-00	External pulse train input type	102	Bit 0: 2--pulse+direction Bit 2: 1--negative logic
*P1-01	Set control mode	0000	Bit 3: Maintaining the set value.Since switching control mode is not used,bit 3--0. Bit 2: 0--forward rotation(CCW)(from the view of load) Bit 1,0: 00--position control mode
P1-44	Electronic gear ratio(numerator)(Z1)	Need calculation	Range: 1~32767; Z1 =Encoder pulses×4; Z2 =Pulse equivalent×Screw pitch×Transmission ratio
P1-45	Electronic gear ratio(denominator)(Z2)	Need calculation	e.g. Pulse equivalent 1000, Screw pitch 10mm, encoder pulses 40000, Transmission ratio 1 $Pn1-44/Pn1-45=40000 \times 4 / 1000 \times 10 \times 1 = 160000 / 10000 = 16 / 1$
P2-10	Function setting for digital input pin DI1	1	Bit 0: Set 1,servo on all the time.
P2-21	Function setting for digital output pin DO1	108	DO1 corresponds to pin-6 & pin-7,used as clamping-position brake signal of Z-axis Bit1,0: 08--set pin-6 and pin-7 as BK- and BK+ respectively. Bit2: 0--set DO15 output as normally closed b-contact point
P2-22	Function setting for digital output pin DO5	007	DO5 corresponds to pin-28 & pin-27,used as servo alarm signal Bit1,0: 07--set pin-28 and pin-27 as ALRM+ and ALRM- respectively. Bit2: 0--set DO5 output as normally closed b-contact point

9.4 G code list

G code list of A1X & A5X	
G00	Rapid positioning
G01	Linear interpolation
G02	Circular interpolation CW
G03	Circular interpolation CCW
G04	Dwell (Unit: millisecond)
G17	Selection of XY coordinate plane
G18	Selection of ZX coordinate plane
G19	Selection of YZ coordinate plane
G20	Input in inch
G21	Input in metric
G28	Auto back to reference point
G30	Back to secondary reference point
G40	Cancel tool radius compensation
G41	Left tool compensation(the tool offsets radius distance on the left side of tool moving direction)
G42	Right tool compensation(the tool offsets radius distance on the right side of tool moving direction)
G43	Tool length compensation (compensation along positive direction)
G44	Tool length compensation (compensation along negative direction)
G49	Cancel tool length compensation
G54	Work coordinate system 1
G55	Work coordinate system 2
G56	Work coordinate system 3
G57	Work coordinate system 4
G58	Work coordinate system 5
G59	Work coordinate system 6
G73	High-speed peck drilling cycle for deep holes
G80	Canned cycle cancel
G81	Drilling cycle
G82	Drilling cycle of dwell at bottom of hole
G83	Peck drilling cycle for deep holes
G84	Righthand tapping cycle
G90	Absolute programming
G91	Incremental programming
G98	Return to initial point
G99	Return to point R
G101	Move with processing speed until the signal is triggered.Meanwhile Rollback and pinpoint signal edge (similar to backing home)
G102	Move with fast speed until the signal is triggered.Meanwhile Rollback and

	pinpoint signal edge (similar to backing home)
G103	Move with processing speed until the signal is triggered.
G104	Move with fast speed until the signal is triggered.
M03	Spindle on(CW rotation)
M04	Spindle on(CCW rotation)
M05	Spindle stop
M06	Tool change
M08	Coolant on (Flood)
M09	Coolant off
M30	End of program,and return to program top
M37	Spindle on(CW rotation)
M38	Spindle on(CCW rotation)
M129	4th spindle on
M208	Cycle machining
M210	Set output logic low level
M211	Set output logic high level
M214	Run the next line of G code after waiting for the specified input signal logic low
M215	Run the next line of G code after waiting for the specified input signal logic high
M216	Run the next line of G code after waiting until all the specified input signal logic high
M217	Run the next line of G code after waiting until anyone of all the specified input signal logic high
M220	Set Y1 logic low level
M221	Set Y1 logic high level
M222	Set Y2 logic low level
M223	Set Y2 logic high level
M224	Set Y3 logic low level
M225	Set Y3 logic high level
M226	Set Y4 logic low level
M227	Set Y4 logic high level
M350	Set the extension output logic low level
M351	Set the extension output logic high level
T	Tool function
S	Spindle speed
F	Feedrate
H	Tool length offset

9.5 Tool setting(Tool measurement)

Tool setting is a process to set up a workpiece coordinate system in machine coordinate system. To put it in other words, tool setting aims to set the workpiece origin.

Including: fixed calibration, mobile calibration.

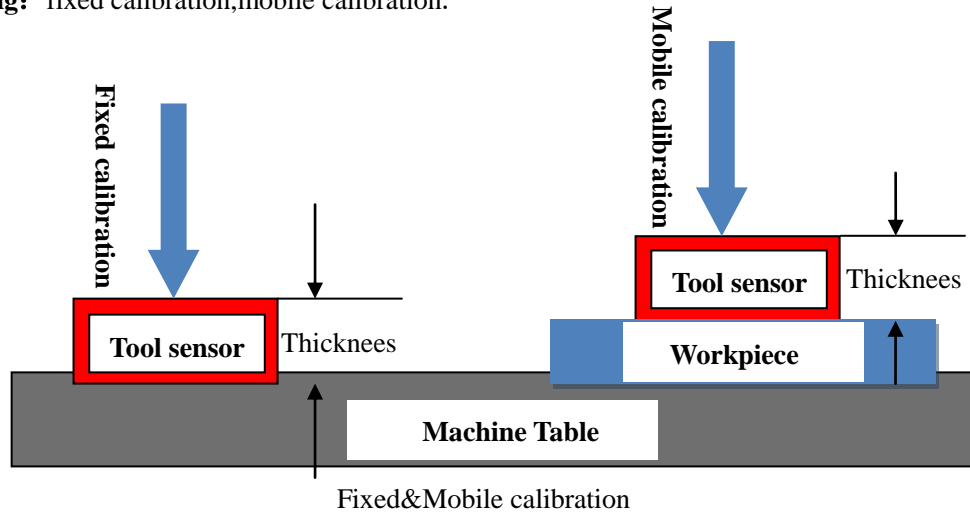

9.5.1 Fixed calibration

Wiring

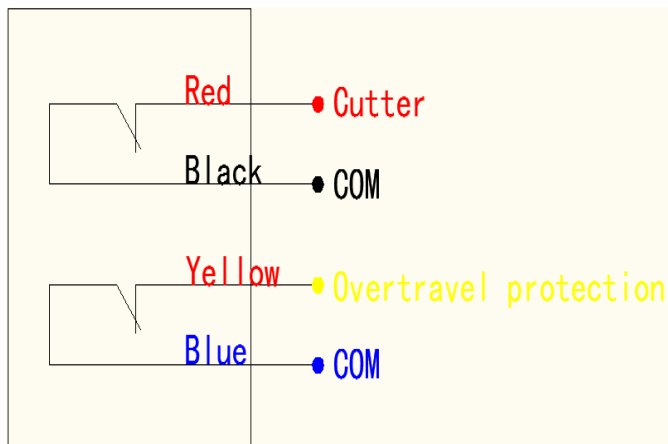

Product picture



Normally open: Cutter signal connects to X4 (X5-A18), COM connects to GND-INPUT SIGNAL
X4: system default normally open.

Normally closed: Firstly, modify the input level of X4 to normally closed, then connect cutter signal to X4 (X5-A18), COM to GND-INPUT SIGNAL.

Overtravel protection signal is similar to cutter signal, users can connect to X7(X8-A18)-- E-stop signal.

Fixed calibration process:

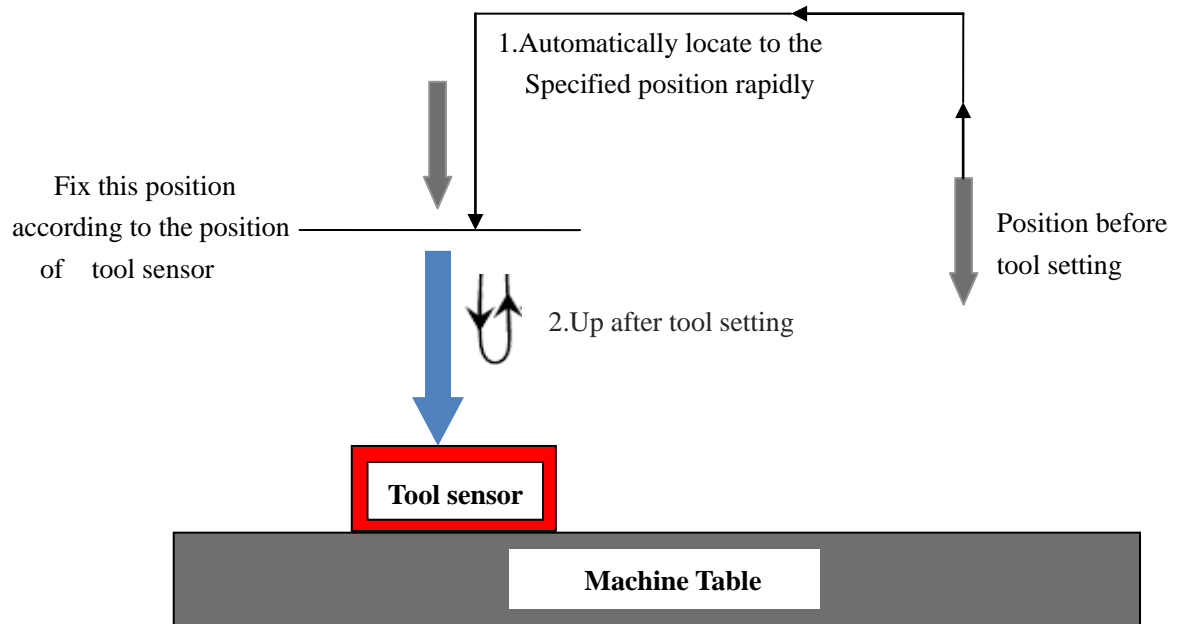

Fixed calibration refers to measurement operation at a certain fixed position on the machine.

During actual machining, tool length and tool holder position will change after tool change because of tool breakage or other reasons. On this occasion, users can conduct fixed calibration to re-confirm the tool length offset.

Instructions:

1) **Set tool sensor position**

Get into “MACHINE SETUP-C.A.D Position” to set tool sensor position, including “Inplace” & “Inposition”



Inposition: Press “ORIGIN OK”, screen displays “Press OK key to set point position by manual mode, it’s very simple but not accurate, press cancel to set by number”. Recommend manual mode.

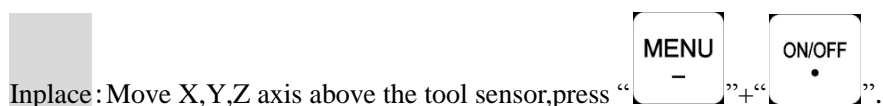

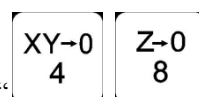

Inplace: Move X, Y, Z axis above the tool sensor, press “MENU -” + “ON/OFF .”.

2) **Tool setting of first time/after tool changing**





1. Manual move Z axis to the surface of workpiece, and press “XY->0 4”, “Z->0 8” to set workpiece

origin of X,Y,Z axis.

2. Press “”+“”to start first time tool setting.The system will record value of offset automatically.

3.Start to processing after first time tool setting.

4.If change another tool or the tool nose has a certain degree of wear and tear,press

“”+“” to start second time tool setting,system will automatically restore to current Z axis workpiece coordinate origin.

5.Start to processing after second time tool setting,do not need press.

Sketch map of tool offset:

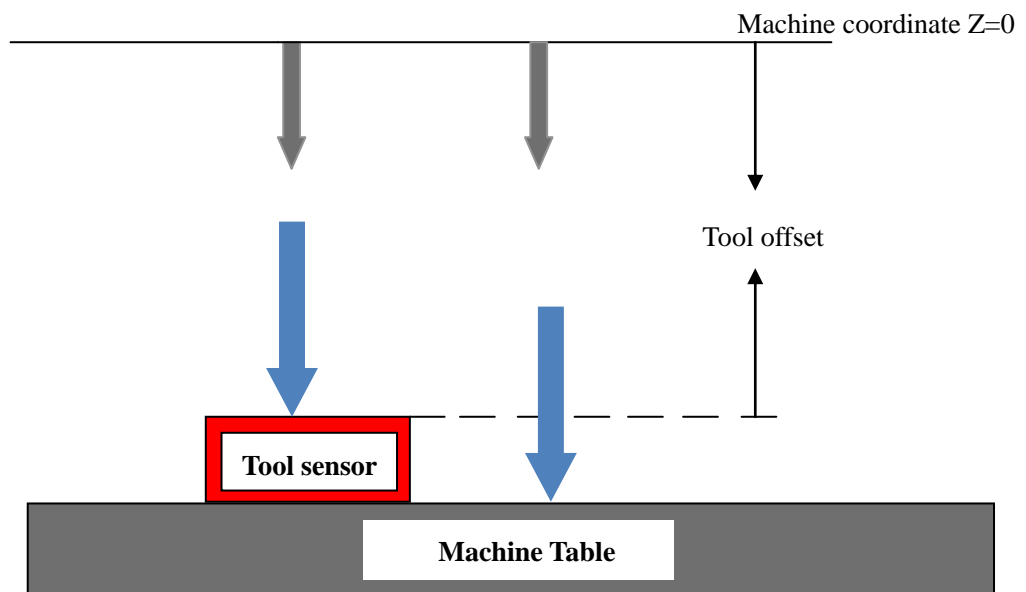

9.5.2 Mobile calibration

Mobile calibration can be used to set workpiece origin of Z axis by executing measurement at the current position.This measurement type will set the workpiece offset according to the calibration result and the following calculation equation.Relationship between workpiece offset and calibration result is as shown below:

Workpiece offset=Mobile calibration result-Tool sensor thickness-Public offset-Tool offset

Generally,the factory setting value of public offset and tool offset is 0,so

Workpiece offset=Mobile calibration result-Tool sensor thickness

After mobile calibration,system will set Z axis workpiece origin automatically.

Mobile calibration process:

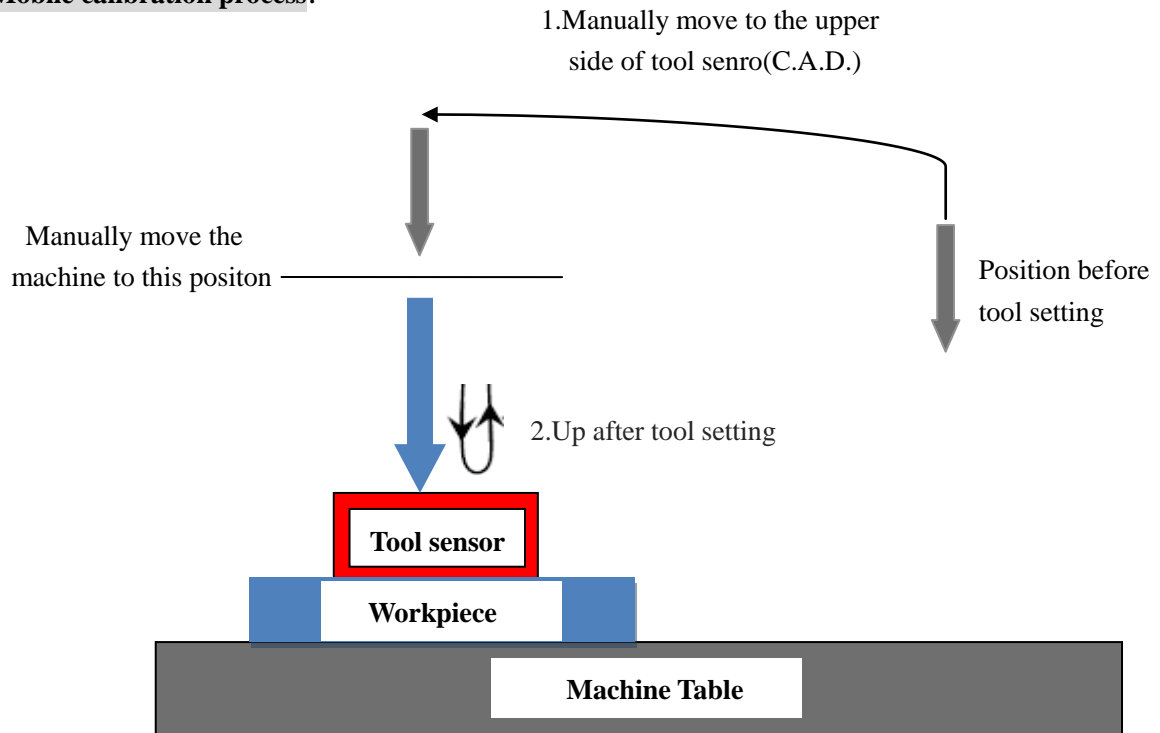

Wiring:

1. The white cable connects to X4 (TS, interface board)
2. The black cable connects to GND(Interface board)

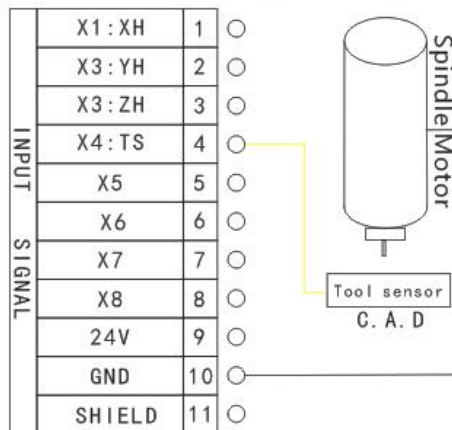



Sensor picture and wiring

Instructions:

The signal cable of tool sensor connects to X4(X5-A18), alligator clip connects to GND-INPUT SIGNAL. (alligator clip also can be clipped on the spindle if the spindle connected to GND)

Place tool sensor onto workpiece,move Z axis to the upper side of the tool sensor in manual

mode,and press “”+“” to start Z-axis automatic tool setting,the system will automatically set the workpiece origin of Z axis.

Mobile calibration usually use simple tool sensor which is affordable, easy and convenient.

Precautions:

Do not rush to make the alligator clipped to the spindle, start the function of tool setting firstly,and then use the alligator clip to touch the spindle,confirm that Z axis tool setting function is carried out normally.

C.A.D. Thickness system default is 0,user need to set it in “MACHINE SEUTP- C.A.D. Thickness”according to actual value.

9.6 Calculate pulse equivalent

9.6.1 Stepper driver

1. linear axis Unit: pul/mm

Formula = pulses per revolution / distance per revolution

Pulses per revolution formula: $(360 \text{ }^\circ / \text{stepper angle}) * \text{Driver subdivision}$

Some stepper drivers mark pulse number directly.

Distance/r formula:

- ▶ Screw drive = screw pitch * mechanical transmission ratio
- ▶ Rack (straight) drive = rack module * gear teeth number * π * mechanical transmission ratio
- ▶ Rack (helical) drive = rack module * gear teeth number * π * mechanical transmission ratio / cos (helical angle)
- ▶ Pulley & belt drive = π * pulley diameter * mechanical transmission ratio

✓ Screw drive:



$$\text{pulse} = \frac{360 \text{ }^\circ}{\text{Stepper angle}} * \text{Driver subdivision} \\ \text{Screw pitch} * \text{transmission ratio}$$

Pulse/rev	SW5	SW6	SW7	SW8
400	ON	ON	ON	ON
800	OFF	ON	ON	ON
1600	ON	OFF	ON	ON
3200	OFF	OFF	ON	ON
6400	ON	ON	OFF	ON
12800	OFF	ON	OFF	ON
25600	ON	OFF	OFF	ON
51200	OFF	OFF	OFF	ON
1000	ON	ON	ON	OFF
2000	OFF	ON	ON	OFF
4000	ON	OFF	ON	OFF
5000	OFF	OFF	ON	OFF
8000	ON	ON	OFF	OFF
10000	OFF	ON	OFF	OFF
20000	ON	OFF	OFF	OFF
40000	OFF	OFF	OFF	OFF

Driver nameplate 1

MSTEP	SW5	SW6	SW7	SW8
2	ON	ON	ON	ON
4	ON	OFF	ON	ON
8	ON	ON	OFF	ON
16	ON	OFF	OFF	ON
32	ON	ON	ON	OFF
64	ON	OFF	ON	OFF
128	ON	ON	OFF	OFF
256	ON	OFF	OFF	OFF
5	OFF	ON	ON	ON
10	OFF	OFF	ON	ON
25	OFF	ON	OFF	ON
50	OFF	OFF	OFF	ON
125	OFF	ON	ON	OFF
250	OFF	OFF	ON	OFF
DISABLE	OFF	ON	OFF	OFF
DISABLE	OFF	OFF	OFF	OFF

Driver nameplate 2



Motor nameplate

Screw pitch (above picture): The distance that the nut moves when the ball screw makes one rotation.

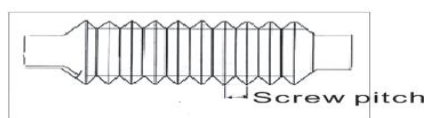

Transmission ratio: The speed ratio or angular velocity ratio of the capstan and the driven wheel.

✓ **Rack drive:**

▶ **Straight rack:**



$$\text{pulse} = \frac{\frac{360^\circ}{\text{Stepper angle}} \times \text{Driver subdivision}}{\text{rack module} \times \text{gear teeth number} \times \pi \times \text{transmission ratio}}$$

▶ **Helical rack:**



$$\text{pulse} = \frac{\frac{360^\circ}{\text{Stepper angle}} \times \text{Driver subdivision} \times \cos(\text{helical angle})}{\text{rack module} \times \text{gear teeth number} \times \pi \times \text{transmission ratio}}$$

✓ **Pulley&belt drive:**

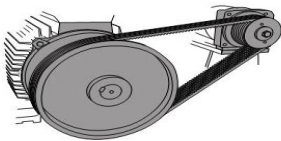

$$\text{pulse} = \frac{\frac{360^\circ}{\text{Stepper angle}} \times \text{Driver subdivision}}{\pi d \times \text{transmission ratio}}$$

d: pulley diameter

2. Pulse equivalent of linear axis

✧ e.g.: pulse/rev=1600, results retain up to three decimal places

➤ **Screw drive**

screw pitch=5mm, pulse equivalent= $\frac{1600}{5} = 320$

➤ **Rack drive**

rack module: 1.25, gear teeth number: 23, π : 3.141592654, transmission ratio: 1/5(0.2)

helical angle: 19°31'42" ($\approx 19.52833333^\circ$)

▶ **Straight rack**

pulse equivalent = $\frac{1600}{1.25 \times 23 \times 3.141592654 \times 0.2} = 88.573$

► **Helical rack**

$$\begin{aligned} \text{pulse equivalent} &= \frac{1600}{1.25 \times 23 \times 3.141592654 \times 0.2 \div \cos(19^\circ 31' 42'')} \\ &= \frac{1600 \times \cos(19.52833333)}{1.25 \times 23 \times 3.141592654 \times 0.2} = 83.478 \end{aligned}$$

NOTES: $1.25 \times 23 \times 3.141592654 \times 0.2 = 18.0641577605$

$$\cos(19.52833333) = 0.94247630504668681677372940102406$$

$$1.25 \times 23 \times 3.141592654 \times 0.2 \div \cos(19.52833333) = 19.1666969915 \approx 19.1667$$

3. Rotation axis Unit: (pul/°)

Formula = pulses per revolution / angles per revolution (360°)



$$\text{pulse} = \frac{360^\circ}{\text{Stepper angle}} \times \frac{\text{Driver subdivision}}{360^\circ \times \text{transmission ratio}}$$

4. Pulse equivalent of rotation axis

◇ e.g.: pulse/rev=1600, transmission ratio = 1/40, results retain up to three decimal places

$$\text{pulse equivalent} = \frac{1600}{360 \times 1/40} = 177.778$$

9.6.2 Servo driver

1. Linear axis

- Screw drive: pulse equivalent * screw pitch * mechanical transmission ratio
- Straigh track: pulse equivalent * rack module * gear teeth number * π * mechanical transmission ratio
- Helical rack: pulse equivalent * rack module * gear teeth number * π * mechanical transmission ratio / cos (helical angle)
- Pulley & belt drive: pulse equivalent * π * pulley diameter * mechanical transmission ratio

2. Calculate electronic gear ratio according to fixed pulse equivalent

Pulse equivalent of handle = 1000

YASKAWA - Numerator Pn20E

YASKAWA Σ -7: Encoder resolution = 16777216 (2^{24}) Set Pn20E = 16777216

YASKAWA Σ -V: Encoder resolution = 1048576 (2^{20}) Set Pn20E = 1048576

YASKAWA- Denominator Pn210

➤ Screw drive

screw pitch=5mm, Pn210= 1000×5=5000

➤ Rack drive

rack module: 1.25,gear teeth number: 23,π: 3.141592654,transmission ratio: 1/5(0.2)

helical angle: 19°31'42" (≈19.52833333°)

◆ Straight rack

Pn210 = 1000×1.25×23×3.141592654×0.2=18064

◆ Helical rack

Pn210 = 1000×1.25×23×3.141592654×0.2÷cos (19.52833333) =19167

DELTA ASDA-B2&A2

B2:Encoder pulses default--N=160000, A2:Encoder pulses default--N=1280000.

e.g.B2 series N=160000

➤ Screw drive

screw pitch=5mm, Denominator M=1000×5 = 5000

$$\text{Electronic gear ratio} = \frac{N}{M} = \frac{160000}{5000} = \frac{32}{1}$$

Set P1-44=32, P1-45=1

➤ Rack drive

rack module: 1.25,gear teeth number: 23,π: 3.141592654,transmission ratio: 1/5(0.2)

helical angle: 19°31'42" (≈19.52833333°)

◆ Straight rack

Denominator M =1000×1.25×23×3.141592654×0.2=18064

$$\text{Electronic gear ratio} = \frac{N}{M} = \frac{160000}{18064} = \frac{10000}{1129}$$

Set P1-44=10000, P1-45=1129

◆ Helical rack

Denominator M =1000×1.25×23×3.141592654×0.2÷cos (19.52833333) =19167

$$\text{Electronic gear ratio} = \frac{N}{M} = \frac{160000}{19167}$$

Set P1-44=160000, P1-45=19167

3. Calculate pulse equivalent according to fixed electronic gear ratio

B2: Electronic gear ratio default--16/10, A2: Electronic gear ratio default--N=128/10

e.g. B2: Set P1-44=1,P1-45=1,Encoder pulses 2500×4=10000

➤ Screw drive

$$\text{screw pitch}=5\text{mm}, \text{ pulse equivalent} = \frac{10000}{5} = 2000$$

➤ Rack drive

rack module: 1.25,gear teeth number: 23, π : 3.141592654,transmission ratio: 1/5(0.2)

helical angle: 19°31'42" ($\approx 19.52833333^\circ$)

◆ Straight rack (results retain up to three decimal places)

$$\text{pulse equivalent} = \frac{10000}{1.25 \times 23 \times 3.141592654 \times 0.2} = 553.582$$

◆ Helical rack(results retain up to three decimal places)

$$\begin{aligned} \text{pulse equivalent} &= \frac{10000}{1.25 \times 23 \times 3.141592654 \times 0.2 \div \cos \left[\frac{\pi}{180} (19^\circ 31' 42'') \right]} \\ &= \frac{10000 \times \cos \left[\frac{\pi}{180} (19.52833333) \right]}{1.25 \times 23 \times 3.141592654 \times 0.2} \\ &= 521.738 \end{aligned}$$

4. Rotation axis

1) Pulse equivalent of handle fixed to1000

YASKAWA Same to linear axis

YASKAWAΣ—7: **Pn20E**= 16777216,YASKAWAΣ—V: **Pn20E**=1048576

transmission ratio =1/40, **Pn210**= 1000×360×1/40=9000

DELTA Same to linear axis

DELTA ASDA-B2 Encoder pulses default--N=160000,A2 Encoder pulses default--N=1280000

e.g. B2: Denominator M=1000×360×1/40=9000,Electronic gear ratio = $\frac{N}{M} = \frac{160000}{9000} =$

$\frac{160}{9}$,Set **P1-44=160**, **P1-45=9**.

2) Calculate pulse equivalent according to fixed electronic gear ratio, set P1-44=1, P1-45=1

Encoder pulses 2500×4=10000

$$\text{pulse equivalent} = \frac{10000}{360 \times 1/40} = 1111.111(\text{results retain up to three decimal places})$$

9.6.3 Proportion calculation method

If there is an error according to the formula or no relevant data to calculate, it can be calculated according to the proportion method. Suppose handle pulse equivalent A, press "

MODE

" switching to distance mode, set a distance B, measuring the number of actual moving distance C, then the actual pulse equivalent = $A \times B \div C$.

For example: Suppose handle pulse equivalent A = 400, f distance B = 100, actual distance C = 80, then the actual pulse equivalent = $400 \times 100 \div 80 = 500$

Repeat until you get the correct pulse equivalent.



9.7 Common problems and troubleshooting

9.7.1 Solutions of the faults display on the screen

1. Screen flicker or automatically restart

- 1) Power supply is insufficient. Check power supply if there are problems, and change high-quality power supply to solve the problems.
- 2) The local power grid unstable. Check local grid voltage stability, or increase the the regulator filter device.
- 3) There are something wrong with the power chip of the handle. This phenomenon also appears when the handle is powered through the USB cable to the computer, please return back the handle to our company.
- 4) Temporary solution, using standard 5V mobile phone charger, power supply through the USB cable to handle. Dual power supply, can temporary emergency use.

2. Fail to set work origin

- 1) Get into the mechanical coordinate system. Press "" + "" to switch to work coordinate system.
- 2) The buttons are broken. SYSTEM SETUP-Buttons Check, to check the buttons are normal or not.

3. Assertion error

Assertion error occurred during the processing or after starting, Is generally a software problem, you can boot assertion emergency recovery, or re-upgrade, if you need to or can not recover Depot Repair

4. Do not read U-disk or errors occurred

- 1) Processing by U-disk, screen shows "There is no item in this direction". Format U-disk to FAT32, allocation unit change to the default configuration size.
- 2) Recommend U-disks of 2G、4G、8G
- 3) There is something wrong with U-disk interface or U-disk is broken, change new U-disk or interface.
- 4) If the connection to U-disk interface is intermittent, users can copy files into inner.
- 5) Program containing the non-standard G code, or some illegal characters, the system read here,

does not recognize, interrupt handling. Recommend using professional simulation software to view the program whether there is an illegal character. Delete all illegal characters.

9.7.2 Faults in practical operation

1. The file size does not match the size of the actual set

- 1) Pulse equivalent is wrong.
- 2) You does not select the right tool.
- 3) Check the processing file.

2. The screen displays“beyond limit”during processing

- 1) The machine is not carried back to zero,the system is not able to confirm the actual position. Make the machine back to zero.
- 2) After setting the working origin, the reserved range is less than the actual file size.Confirm the actual file size and set correct working origin.
- 3) You set the wrong working origin in the file. Check the path of the file, and re-export the correct file.

3.Hard limit false triggering

- 1) System has connected with hard limit signal: maybe hard limit switch is broken or voltage setup X6(X7-A18) is wrong.
- 2) System has not connected with hard limit signal: confirm that whether connect other signal to hard limit X6(X7-A18),if not,check voltage setup normal or not,if normal,MACHINE SETUP-Input Confi-disable X6(X7-A18), then wipe cache and system upgrade.

4.Z axis (spindle) fall down abnormally (too fast) during processing

- 1) Working speed beyond the fastest speed of Z axis. " MACHINE SETUP " - " Max Spd Limit ", set the safe speed.
- 2) Coupling is loosing or transmission slippages. Re-adjustment the connecting parts.
- 3) The lines connect the interface board with the motor drivers has disruption. Re-adjust the lines.
- 4) Processing file error. Check processing file, try to download the correct processing file to U disk or handle internal.
- 5) There is something wrong with the lines connectting Z axis motor and motor driver. Replace the lines.

5. Repeating the same processing file after backing to the machine origin, Z axis depth is not the same

- 1) Machining countertop is uneven or processing object not firmly fixed, re-milling countertop adjust the flatness.
- 2) Z-axis origin detection switch repeat positioning accuracy error, causing each Z axis homing error. Replace a high-quality detection switch.
- 3) Too much interference in the Z-axis homing process to form a false origin. Re-adjust the cable.

6. The machine can not stop after backing to the machine origin

Double press “” to check input signal.

- 1) The origin detection switch is broken. Replace a new one.
- 2) The distance of the origin detection switch detection sheet beyond the detection range of the switch, adjust the position of the test piece.
- 3) The origin detection switch to the interface board wiring aging or loosening. Check the connections again.
- 4) The interface board is broken. Depot Repair.
- 5) 50-pin data cable is broken. Replace it with a new data cable.

7. The machine moves to the reverse direction when backing to the machine origin

- 1) The origin detection switch types do not match with the definition of the corresponding level. Modify the level. (Normally open type corresponds to a level defined the direction of the arrow down, normally closed type corresponds to the level defined arrow up).
- 2) The origin detection switch is broken. Replace a new one.
- 3) The origin detection switch connects interface board not well. Refresh the cable to confirm the wiring is correct.
- 4) Too much interference, resulting in the illusion of the detection switch has been triggered. Recalibrated the whole circuit.
- 5) The interface board is broken. Depot Repair.
- 6) 50-pin data cable is broken. Replace the data cable.

8. Abnormally working when processing or the actual file is different from theoretical file

- 1) The system disorder.。
- 2) Too much external interference.Refresh connection. (Separate low voltage from high voltage, "GND" of inverter separated from the other components).
- 3) There is something wrong during the process of ENG change to NC.

9.Start automatic tool setting, the tool does not stop after touching C.A.D(Tool sensor).

- 1) Cutter signal cable connects X4(X5-A18) not well.
- 2) The "GND" terminal of interface board does not connect with spindle shell or connect not well.
- 3) MACHINE SETUP-Input Confi,confirm that X4(X5-A18) enable.

10. Coordinate value changes changes, the machine does not move

- 1) If one axis is not moving, it may be a connection problem. Change another normal terminal to this terminal,if it is ok,the motor dirver is ok.Maybe there is something wrong with interface board、 50-pin cable. If it is still not moving, it is necessary to detect the corresponding drive and motor.
- 2) If all axes are not moving ,firstly check if there are problems in the 50-pin cable and interface,secondly check the power supply of the motor drivers.
- 3) Check the mechanical parts.

11. It is normal to the move from one position to another position, but when return from that position to the original position is not normal

Mechanical problems, screw may install not well.

12. Direction of movement is wrong

- 1) Exchange A+&A-/B+&B- cable of stepper motor
- 2) Change motor direction mask(not recommended)

13. The machine vibrates when arc or two-axis linkage movement

- 1) Check whether the machine is placed horizontally,
- 2) Check coupling member loose or not.
- 3) Increasing the start speed, avoid the resonance point.

9.7.3 Electrical components and wiring problem

1. One axis or multi-axis only one-way movement after handle power up

- 1) There is something wrong with the cable connect the interface board with the motor driver, check the connection.
- 2) Interface board is broken. Replace the interface board.
- 3) The motor driver is broken. Replace the driver.
- 4) Measure the direction voltage of the axis with a multimeter.

2. One axis motor does not move after handle power up

- 1) Pulse cable and direction cable connect oppositely, rewiring it.
- 2) 5V common anode end of the motor driver disconnected, check the connection.
- 3) The motor driver is broken, change to a new one.
- 4) The chip of the interface board is broken, no pulse signal output.
- 5) Change this terminal to another normal terminal to check interface board abnormal or driver abnormal.

3. Screen is not bright after power up, and connected handle to computer with a USB cable the screen displays normal

- 1) The handle does not connect to power supply. Check DC24V power supply output normal or not, if normal, please check the cable from the power supply to the interface board.
- 2) The 50-pin cable is broken or the interface is broken.

4. Screen is not bright after power up, and connect the handle to computer by USB cable, the screen is also not bright

- 1) This phenomenon may be due to the handle shocked by external force or fall on the ground, causing the crystal processor broken. Depot Repair.
- 2) Users connect high voltage power supply. Depot Repair.

5. The screen display "Spindle on", actually the spindle off, the screen display "Spindle off", actually the spindle on

- 1) There is something wrong with cables. Check cables.
- 2) The output level definition is wrong. Modify correct output level definition.

6. System always alarm after the alarm signal has been connected

Change the input level of X5(X6-A18) (normally open, wiring in parallel, normally closed,

wiring in series)

7. Press spindle on, but spindle does not start

- 1) Check wiring, if normal, check interver and spindle motor.
- 2) Check 50-pin cable.

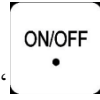

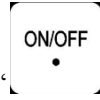
- 3) Check interface board. Press “” to start spindle, use multimeter to measure Y1 and GND whether conducting, if not, maybe interface or 50-pin cable is broken.